

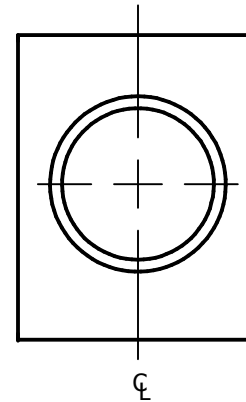

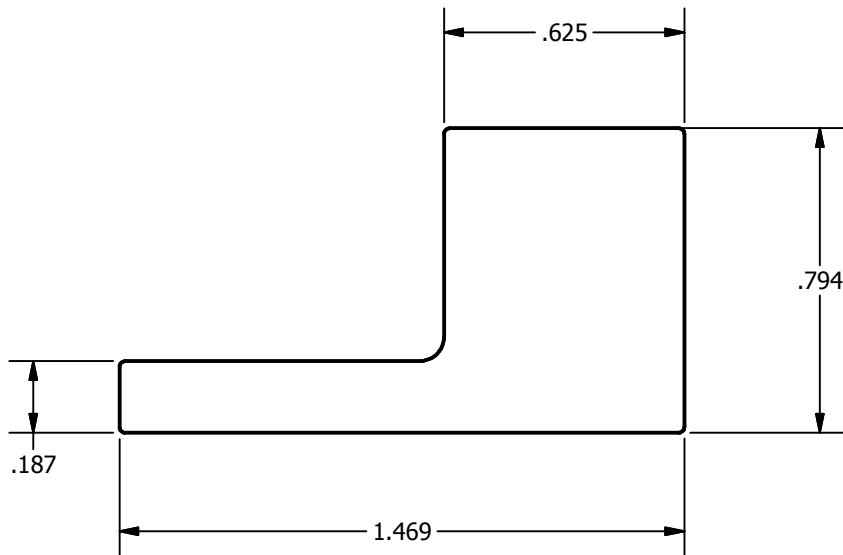

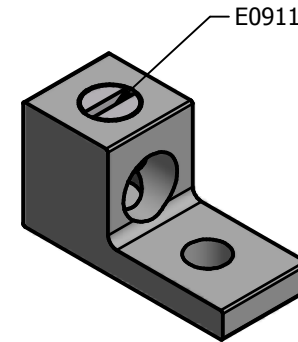

SCREW: E0911	MATERIAL: ALUMINUM	REV: L		
CAT. NO.: TA-0	PLATING: EL-TIN	DRAWN BY: NN	SCALE: 2:1	
INFORMATION SHEET: FORM 1	MARKING: SEE CHART	DATE: 12/4/2007	SIZE: A	
		800-776-9775		www.ilsco.com
		DWG. NO. <b>D0830</b>		
		SHEET: 1 OF 1		

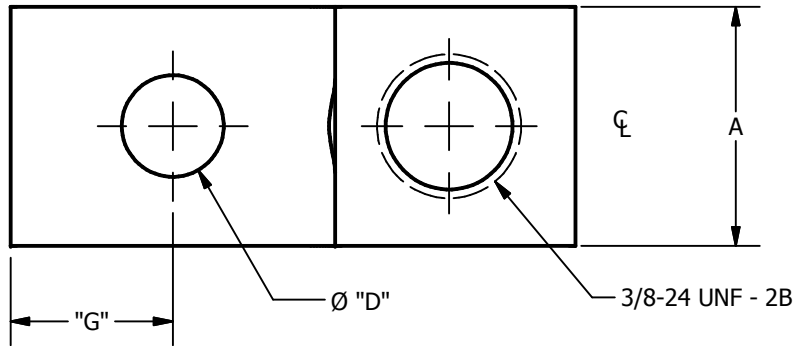

DEV	MOUNTING HOLE "D"	"G"	MARKING
-10	.265	.422	BKB, ADR11, AL9CU, 1/0-14. 
-22	.265	.422	ILSCO, TA-0, 1/0-14, AL9CU 
-24	.198	.422	ILSCO, TA-0, 1/0-14, AL9CU 
-26	.406	.422	ILSCO, TA-0, 1/0-14, AL9CU 
-28	.265	.297	ILSCO, TA-0, 1/0-14, AL9CU 
-46	.406	.422	ILSCO, TA-0, 1/0-14, AL9CU 
-48	.328	.422	ILSCO, TA-0, 1/0-14, AL9CU 