

8ⁱⁿ1

CONFIGURATIONS

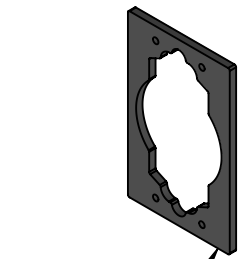

Gasket, 1-Gang, Enclosure Base Gasket

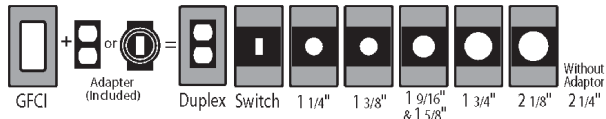
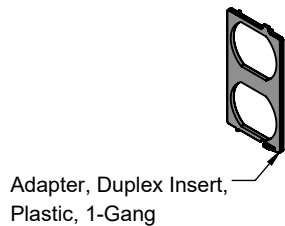

Adapter, Duplex Insert, Plastic, 1-Gang



Adapter, 1-Gang, Switch / Round, 6-IN-1, GFCI Base

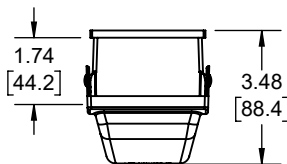

2X
Machine Screw, 6 - 32 x 1",
Phillips Pan Head

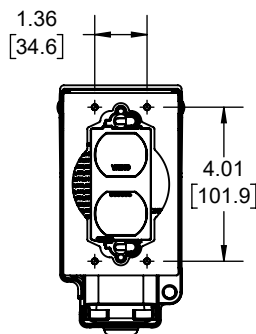
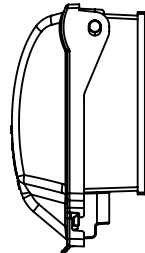
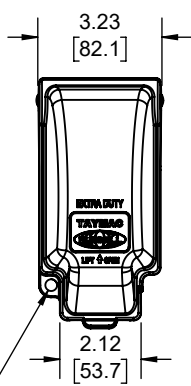
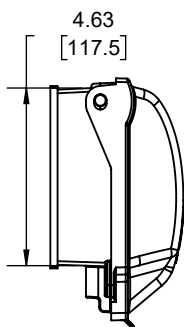

Ø.31 [7.8]

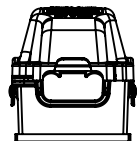

REVISIONS			
REV.	DATE	DESCRIPTION	BY:
-	02-27-20	INITIAL RELEASE	TCY

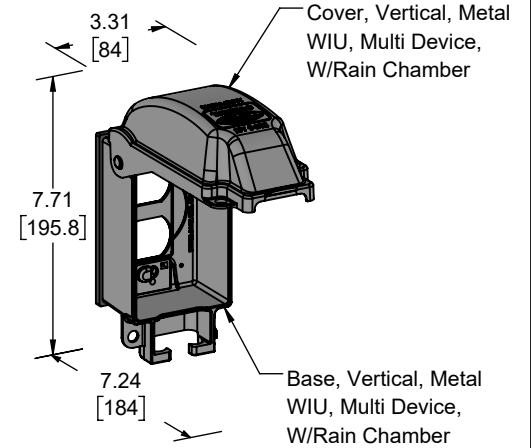
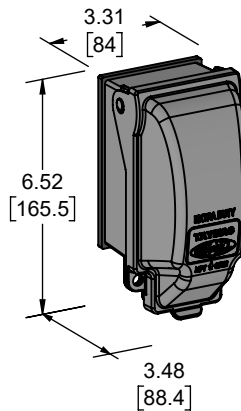

MACHINE SCREW	STEEL	ZINC COATED
GASKET	PE FOAM	GRAY
ADAPTER	PLASTIC	GRAY
COVER	ALUMINUM	GRAY
BASE	ALUMINUM	GRAY
DESCRIPTION	MATERIAL	FINISH

LIST OF PARTS

THE DESIGN AND DIMENSIONS OF THE PRODUCT SHOWN ON THIS DRAWING ARE SUBJECT TO CHANGE WITHOUT NOTICE

TITLE:

Metal WIU, Extra Duty, 1 Gang, Vertical, Multi Device, W/Rain Chamber

TOLERANCE UNLESS OTHERWISE SPECIFIED

.XX DECIMAL ± .015
.XXX DECIMAL ± .005
ANGLE ± 2°



DRAWN BY:	TCY	SCALE:	SIZE:
APP. BY:	N.S.		
DATE:	02-27-20	1:5	A

NOTES:

- ALL DIMENSIONS ARE IN INCHES AND [MILLIMETERS]
- cULus LISTED

FILE NO.:
MX3200 CUS

DIMENSION SHEET FOR CAT. NO.
MX3200 CUS

8.5in 1 in

CONFIGURING THE BASE • CONFIGURACIÓN DE LA BASE

Duplex

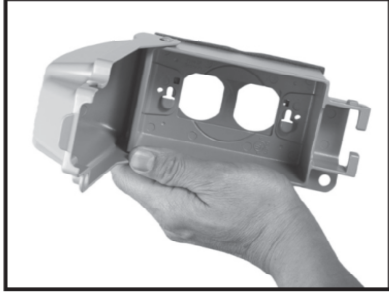

Comes pre-configured with duplex adapter installed.

Viene pre-configurado para duplex

GFCI

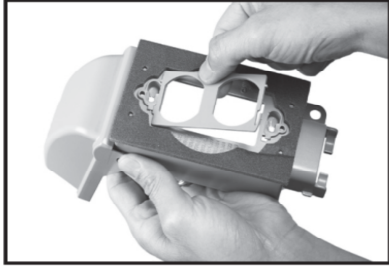

For GFCI, remove duplex adapter from back.

Para GFCI deslice el adaptador dúplex a la espalda de la base.



GFCI ready.

GFCI listo.

Toggle Switches / Round Receptacles • Interruptores de Palanca / Receptáculos Redondos

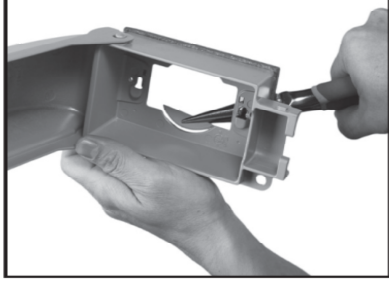

For toggle/round devices, break out both round pieces using pliers.

Para dispositivos de palanca / redondos, quitar las piezas de las orillas utilizando pinzas.

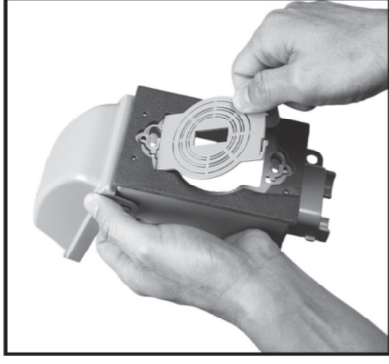

Adapter comes ready for toggle switch. For rounds, use pliers to incrementally snap off rings until desired circumference is achieved. Snap adapter onto back of base.

Adaptador viene listo para el interruptor. Para las redondos utilizar pinzas para remover incrementalmente los anillos hasta circunferencia deseada.

MO3200_MS_REV.0

INSTALL UNIT • PARA INSTALAR LA UNIDAD

DIAGRAM: GFCI Installation

DIAGRAMA: Instalación de GFCI

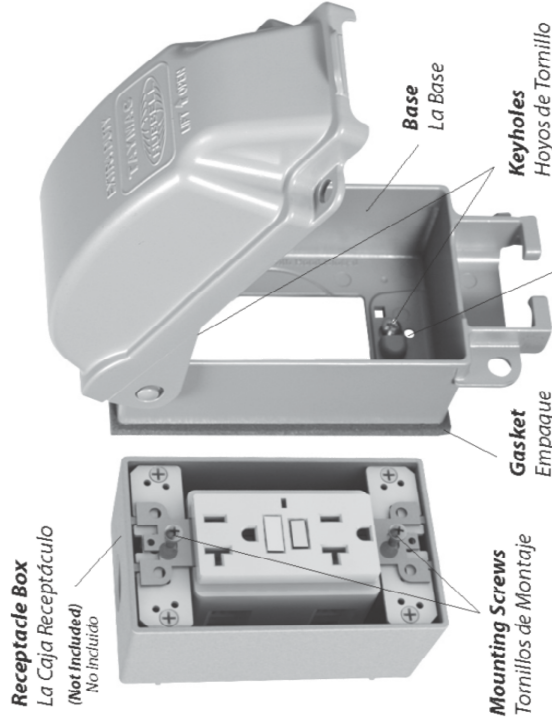

Receptacle Box
La Caja Receptáculo
(Not Included)
No Incluido

Mounting Screws
Tornillos de Montaje

Gasket
Empaque

Base
La Base

Keyholes
Hoyos de Tornillo

Alternate Device Mounting Holes
Agujeros de montaje de dispositivos alternativos

IMPORTANT: Turn off power to outlet.

IMPORTANTE: Desconecte corriente del circuito del desaque o toma.

IMPORTANT: Turn off power to receptacle at the circuit breaker box or equivalent. Configure base as shown on other side. Back out mounting screws. Do not remove screws. (Note: Make sure that box is flush or slightly behind the finished surface and that receptacle is flush with the finished surface in accordance with NEC 406.4 and 314.20.) Align keyholes on base with screws and slide to the left. Tighten screws until snug (avoid overtightening).

NOTE: Base should be installed on a smooth flat surface. To ensure a weatherproof seal on irregular surfaces such as brick or cedar siding, a 1/4 inch bead of non-hardening silicone caulk (not included) must be placed between the gasket and the mounting surface

WARNING: Improper installation of any electrical device can cause serious injury or death.

CAUTION: Device must protrude through the base or duplex/round adapters. If not, please use UL approved spacers (not included) to move the device forward in the box.

IMPORTANTE: Desconecte corriente del circuito del desaque o toma. Configure la base como se ilustra al lado. Retroceder tornillos de montaje. No quitar. (Nota: Asegure que la caja este a nivel con la pared o un poco mas abajo de la superficie terminada y el receptor este a nivel de la superficie terminada de acuerdo con el NEC 406.4 y 314.20.) Alinee las ranuras de la base con los tornillos y mueva hacia la derecha. Apriete los tornillos (evitar un apriete excesivo).

NOTA: La base deberá instalarse en una superficie suave y plana. A fin de garantizar un sello a prueba de agua en superficies irregulares, tales como ladrillo o tablas de cedro, se deberá colocar un reborde de 1/4 de pulgada de calafateo de silicon (no incluido) flexible entre el empaque y la superficie de montaje.

AVISO: Instalación incorrecta del algun aparato eléctrico puede causar heridas graves o hasta la muerte.

PRECAUCION: El aparato debe salir de la base o duplex/adaptador redondo. Si no utilice expansiones aprobados por UL (no incluidos) para mover el aparato hacia el frente de la caja.