

# HVSA

Armoring Modification Kits for 3/C Cable

## Suggested Installation Equipment (not supplied with kit)

- Cable preparation tools
- Tyco Electronics P63 cable preparation kit or cable manufacturer approved solvent
- Clean, lint-free cloths
- Non-conducting abrasive cloth, 120 grit or finer
- Electrician's tape
- Connector(s) and installation tools
- Tyco Electronics recommended torch

## Safety Instructions

**Warning:** When installing electrical power system accessories, failure to follow applicable personal safety requirements and written installation instructions could result in fire or explosion and serious or fatal injuries.

To avoid risk of accidental fire or explosion when using gas torches, always check all connections for leaks before igniting the torch and follow the torch manufacturer's safety instructions.

To minimize any effect of fumes produced during installation, always provide good ventilation of confined work spaces.

*As Tyco Electronics has no control over field conditions which influence product installation, it is understood that the user must take this into account and apply his own experience and expertise when installing product.*

## Recommended Tyco Electronics Torches

Install heat-shrinkable cable accessories with a "clean burning" torch, i.e., a propane torch that does not deposit conductive contaminants on the product.

Clean burning torches include the Tyco Electronics FH-2629, FH-2649 (uses refillable propane cylinders) and FH-26 18A (uses disposable cylinder).

## Adjusting the Torch

Adjust regulator and torch as required to provide an overall 12- inch bushy flame. The FH-2629 will be all blue, the other torches will have a 3- to 4-inch yellow tip. Use the yellow tip for shrinking.

## Regulator Pressure

FH-26 18A	Full pressure
FH-2649	25 psig
FH-2629	15 psig

## General Shrinking Instructions

- Apply outer 3- to 4-inch tip of the flame to heat-shrinkable material with a rapid brushing motion.
- Keep flame moving to avoid scorching.
- Unless otherwise instructed, start shrinking tube at center, working flame around all sides of the tube to apply uniform heat.

To determine if a tube has completely recovered, look for the following, especially on the back and underside of the tube:

1. Uniform wall thickness.
2. Conformance to substrate.
3. No flat spots or chill marks.
4. Visible sealant flow if the tube is coated.

*Note: When installing multiple tubes, make sure that the surface of the last tube is still warm before positioning and shrinking the next tube. If installed tube has cooled, re-heat the entire surface.*

# Installation Instructions

## 1. Product selection.

Check kit selection with cable diameter dimensions shown in Table 1.

Table 1

HVSA Kit	For Use With 1/C Kit	Conductor Size Range	Insulation Diameter	Connector Dimensions Length O.D.
HVSA-1	HVS-501	#6-#1 AWG	0.40-0.70" (10-18mm)	3.00" (75mm) 0.65" (16mm)
	HVS-502	1/0-300 kcmil	0.65-1.05" (17-26mm)	4.00" (100mm) 1.00" (25mm)
	HVS-821S (5kV)	#6-2/0 AWG	0.35-0.65" (9-16mm)	3.00" (75mm) 0.50" (12mm)
	HVS-821S (8kV)	#6-#2 AWG	0.35-0.65" (9-16mm)	3.00" (75mm) 0.50" (12mm)
HVSA-2	HVS-503	350-1000 kcmil	0.95-1.65" (24-42mm)	6.00" (150mm) 1.85" (47mm)
	HVS-822S (5kV)	3/0-300 kcmil	0.55-0.90" (14-22mm)	4.25" (110mm) 0.75" (19mm)
	HVS-822S (8kV)	#1-4/0 AWG	0.55-0.90" (14-22mm)	4.25" (110mm) 0.75" (19mm)
	HVS-823S (5kV)	350-750 kcmil	0.80-1.25" (20-31mm)	6.00" (150mm) 1.10" (28mm)
	HVS-823S (8kV)	250-350 kcmil	0.80-1.25" (20-31mm)	6.00" (150mm) 1.10" (28mm)
HVSA-3	HVS-824S (5kV)	1000-1500 kcmil	1.00-1.60" (25-40mm)	8.00" (200mm) 1.45" (37mm)
	HVS-824S (8kV)	500-750 kcmil	1.00-1.60" (25-40mm)	8.00" (200mm) 1.45" (37mm)
	HVS-825S (8kV)	750-1000 kcmil	1.30-2.25" (33-57mm)	8.00" (200mm) 1.85" (47mm)
	HVS-1521S	#2-4/0 AWG	0.65-1.05" (17-26mm)	4.25" (110mm) 0.90" (23mm)
	HVS-1522S	250-350 kcmil	0.90-1.30" (23-33mm)	5.50" (140mm) 1.15" (29mm)
	HVS-1523S	500-750 kcmil	1.10-1.60" (28-40mm)	8.00" (200mm) 1.60" (40mm)
	HVS-1524S	750-1000 kcmil	1.25-1.80" (31-45mm)	8.00" (200mm) 1.85" (47mm)
	HVS-2521S	#1-250 kcmil	0.90-1.20" (23-30mm)	4.00" (100mm) 1.10" (28mm)
	HVS-2522S	350-500 kcmil	1.20-1.50" (30-38mm)	6.00" (150mm) 1.35" (34mm)
	HVS-3521S	1/0-3/0 AWG	0.95-1.35" (24-34mm)	5.00" (100mm) 1.00" (25mm)
HVSA-4	HVS-2523S	750-1000 kcmil	1.50-1.80" (38-45mm)	8.00" (200mm) 1.85" (47mm)
	HVS-3522S	4/0-600 kcmil	1.30-1.70" (33-43mm)	8.00" (150mm) 1.50" (38mm)
	HVS-3523S	700-1000 kcmil	1.65-2.15" (42-54mm)	10.00" (200mm) 1.85" (47mm)

**Note:** The HVSA Armoring Mod kits are designed for use with three standard 1/C splice kits to create a 3/C armored splice kit.

Discard the outer re-jacketing tube or wrap-around sleeve included in each 1/C shielded kit. Do not discard re-jacketing tubes in non-shielded kits.

Discard the instructions included in the 1/C splice kits and continue with Step 2 below.

## 2. Remove 3/C cable jacket.

Refer to Table 2 and Figure 1 and cut back the cable jacket as shown. (Copper tape shielded cable shown).

Table 2

Kit	Jacket Cutbacks	
	A1	A2
HVSA-1	23-1/2" (570mm)	13-1/2" (240mm)
HVSA-2	30-1/2" (775mm)	16-1/2" (420mm)
HVSA-3	41" (1041mm)	22" (559mm)
HVSA-4	48-1/2" (1230mm)	25" (635mm)

Figure 1

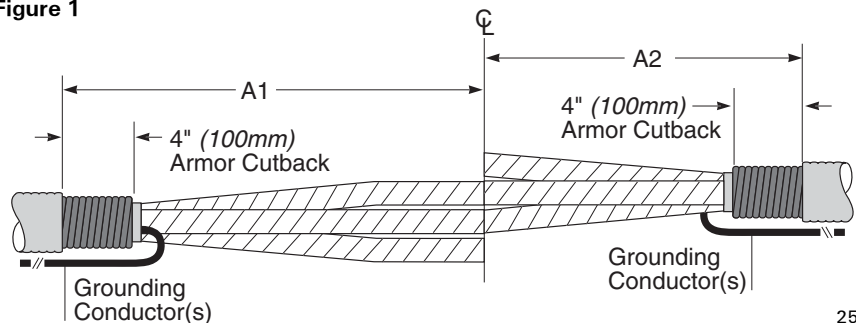

2532

### 3. Prepare cables.

Choose the cable type (Choice 1-3) and use the dimensions shown in Table 3 to prepare the cables.

**Table 3**

Kit	Metallic Shield		Semi-con	Kit	Metallic Shield		Semi-con
	B	Cutback	C		B	Cutback	C
<b>5-8kV</b>				<b>25kV</b>			
HVS-821S	6"	(150mm)	3-1/4" (80mm)	HVS-2521S	9"	(230mm)	5-1/2" (140mm)
HVS-822S	7"	(180mm)	4" (100mm)	HVS-2522S	10-1/2"	(265mm)	6-3/4" (170mm)
HVS-823S	8"	(200mm)	5" (125mm)	HVS-2523S	12"	(305mm)	7-3/4" (195mm)
HVS-824S	9-1/2"	(240mm)	6" (150mm)				
HVS-825S	10"	(250mm)	6" (150mm)				
<b>15kV</b>				<b>35kV</b>			
HVS-1521S	8"	(203mm)	4-1/2" (115mm)	HVS-3521S	11"	(280mm)	7-1/4" (170mm)
HVS-1522S	9"	(230mm)	5" (125mm)	HVS-3522S	14"	(305mm)	8" (200mm)
HVS-1523S	10"	(255mm)	6-1/2" (165mm)	HVS-3523S	15"	(340mm)	10" (230mm)
HVS-1524S	10-1/2"	(265mm)	6-1/2" (165mm)				
HVS-1525S	12"	(305mm)	8" (203mm)				

#### CHOICE 1

##### If Metallic Tape Shield Cable

Refer to Table 3 and prepare the cables as shown. Remove any fillers to the armor cutback. Bend back the grounding conductor(s) over the jacket as shown.

Go to Step 4, page 5.

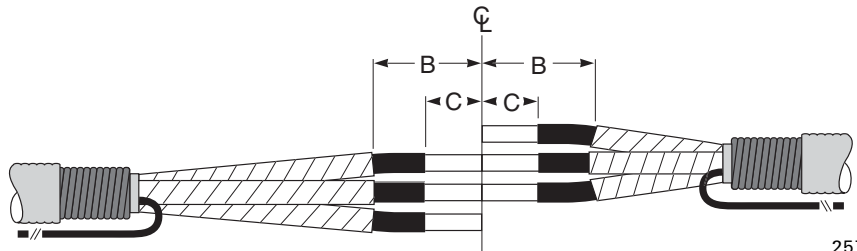

2574

#### CHOICE 2

##### If Drain Wire Shield Cable

Refer to Table 3 and prepare the cables as shown. Remove any fillers to the armor cutback. Pull drain wires back to Dimension B and temporarily tape over ends as shown. Bend back the grounding conductor(s) over the jacket as shown.

Go to Step 4, page 5.

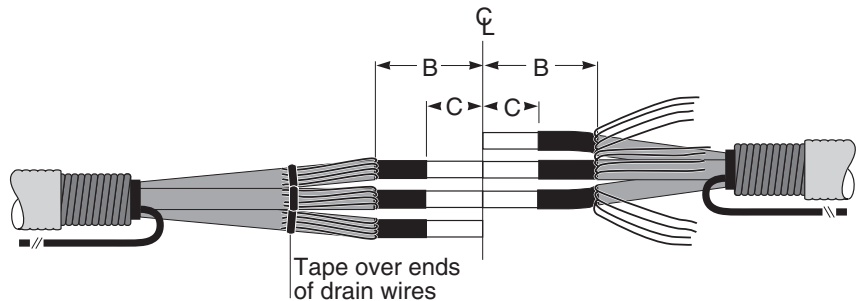

2575

#### CHOICE 3

##### If UniShield Cable

Refer to Table 3 and prepare the cables as shown. Remove any fillers to the armor cutback. Pull drain wires back to Dimension B and temporarily tape over ends as shown. Bend back grounding conductor(s) over the jacket as shown.

Go to Step 4, page 5.

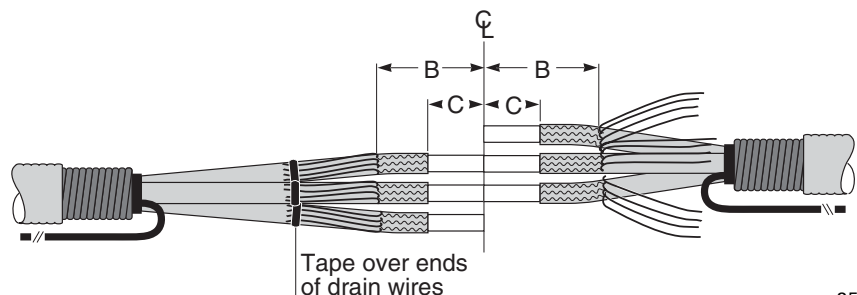

2576

**Table 4**

Kit	Maximum Connector Length	Dimensions	Diameter
<b>5kV Non-shielded</b>			
HVS-501S	3" (76mm)	0.65"	(16mm)
HVS-502S	4" (102mm)	1.00"	(25mm)
HVS-503S	6" (152mm)	1.85"	(47mm)
<b>5-8kV</b>			
HVS-821S	3" (76mm)	0.50"	(13mm)
HVS-822S	4-1/4" (108mm)	0.75"	(19mm)
HVS-823S	6" (152mm)	1.10"	(28mm)
HVS-824S	8" (203mm)	1.45"	(37mm)
HVS-825S	8" (203mm)	1.85"	(47mm)
<b>15kV</b>			
HVS-1521S	4-1/4" (108mm)	1.00"	(25mm)
HVS-1522S	5-1/2" (140mm)	1.35"	(34mm)
HVS-1523S	8" (203mm)	1.60"	(41mm)
HVS-1524S	8" (203mm)	1.85"	(47mm)
HVS-1525S	8" (203mm)	2.40"	(60mm)
<b>25kV</b>			
HVS-2521S	4" (102mm)	1.00"	(25mm)
HVS-2522S	6" (152mm)	1.55"	(39mm)
HVS-2523S	8" (203mm)	1.85"	(47mm)
<b>35kV</b>			
HVS-3521S	5" (102mm)	1.00"	(25mm)
HVS-3522S	8" (152mm)	1.50"	(39mm)
HVS-3523S	10" (203mm)	1.85"	(47mm)

**4. Remove insulation.**

Refer to Table 5 and Figure 2 to cutback insulation as shown.

**Table 5**

Conductor Size	Expansion Gap "X"
less than 350kcmil	1/4" (5mm)
350 kcmil or greater	1/2" (10mm)

**Figure 2**

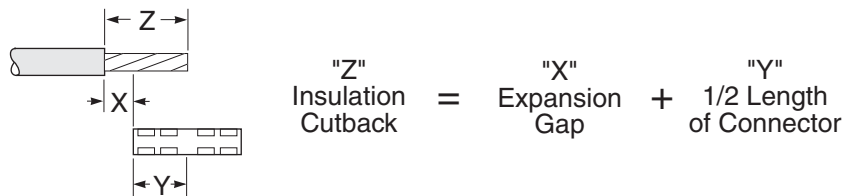

**5. Choose cable type and action required.**

Cable Description	Action
5kv Non-shielded	go to Step 6, Page 5
5-8kV Shielded	go to Step 13, Page 7
15kV, 25kV, 35kV	go to Step 21, Page 9

## 5-8kV Non-shielded

### 6. Clean cables.

Using an oil-free solvent, clean the cables as shown.

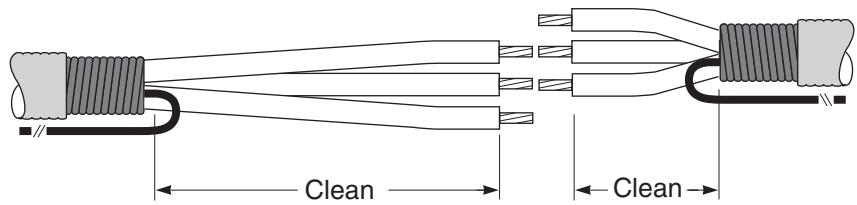

2006

### 7. Place tubes over phases.

Nest the red insulating tube into the black sealing tube and place one set over each phase as shown (on long side).

Protect tubes from end of conductor as they are placed over cable end.

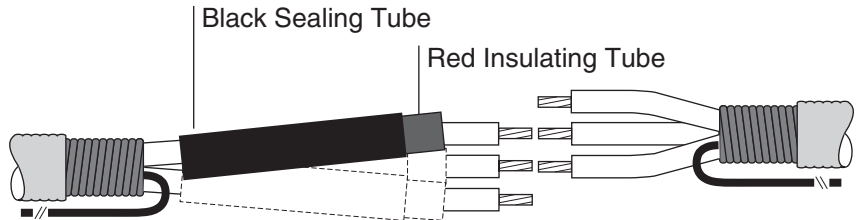

2007

### 8. Install connectors.

After installation, deburr connectors.

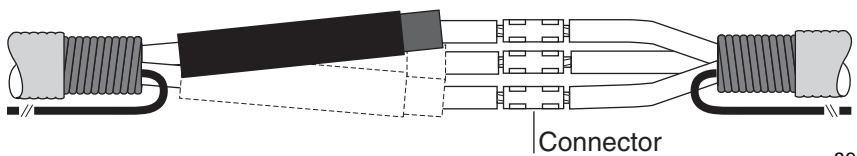

2008

### 9. Apply SRM over connector.

Complete Steps 9 and 10 working on one phase at a time.

Clean connector area and insulation, as shown, using an oil-free solvent.

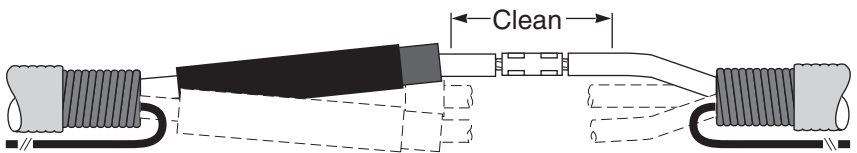

2009

Remove backing from one side of the strip of Stress Relief Material (SRM). Roll the SRM and remaining backing strip into a convenient size. Remove the remaining backing strip and tightly wrap the SRM around the connector and exposed conductor. Be sure to fill the gaps and low spots around the connector.

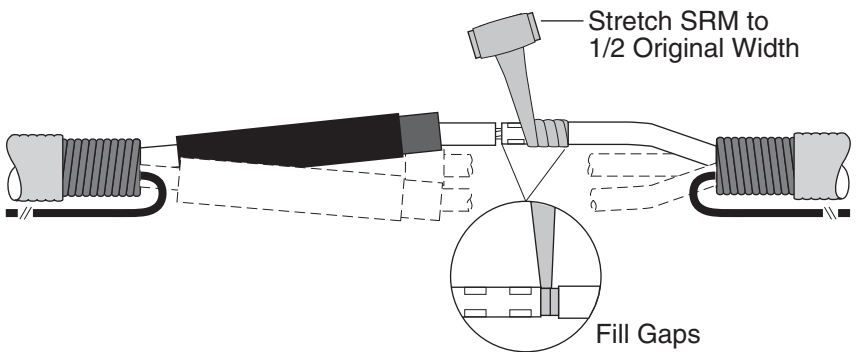

2010

Continue to wrap SRM onto the solvent cleaned insulation as shown.

**Note:** If connector diameter is larger than insulation diameter, apply two tightly wrapped half-lapped layers of SRM over the entire connector. Discard any excess SRM.

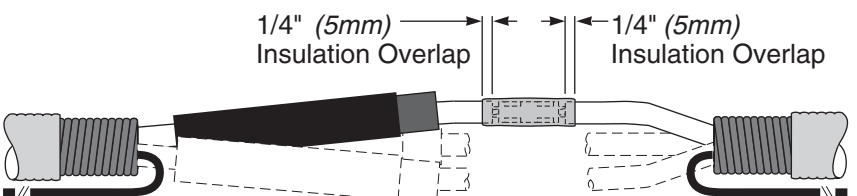

2011

**10. Position tube over connection.**

Center the red insulating tube over completed connector area. Do not shrink yet.

**Repeat Steps 9 and 10 on the remaining phases.**

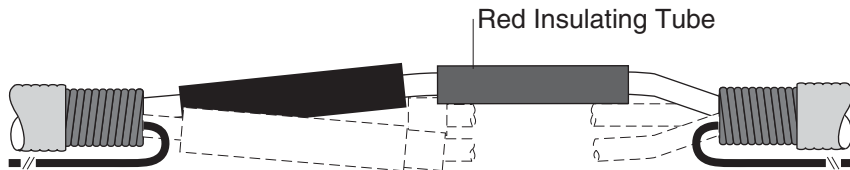

2012

**11. Check position of red insulating tubes; shrink in place.**

Make sure each tube is centered over the connection area. Shrink all three tubes in place at the same time.

Begin shrinking at center of tubes (1), working torch with a smooth, brushing motion around the tubes. After center portion shrinks, work torch as before toward one end (2), then to the opposite end (3). Apply sufficient heat to ensure softening of the SRM, indicated by a smooth surface profile.

**Note:** Do not point the flame directly at the cable insulation.

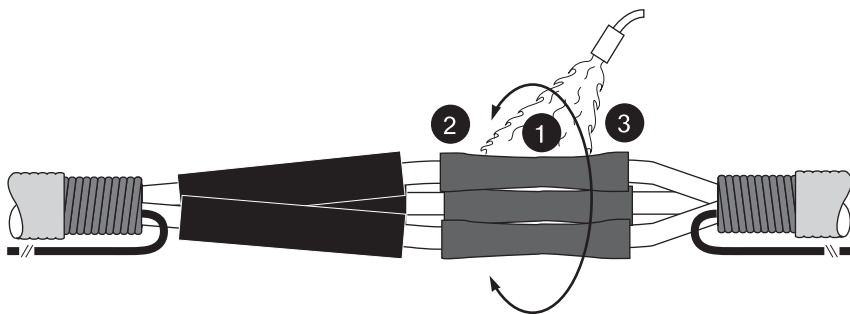

2013

**12. Position black sealing tubes; shrink in place.**

Make sure each tube is centered over the connection area. Shrink all three tubes in place at the same time.

Begin shrinking at center of tubes (1), working torch with a smooth, brushing motion around the tubes. After center portion shrinks, work torch as before toward one end (2), then to the opposite end (3).

**Note:** Do not point the flame directly at the cable insulation.

**Skip to Step 32, Page 13.**

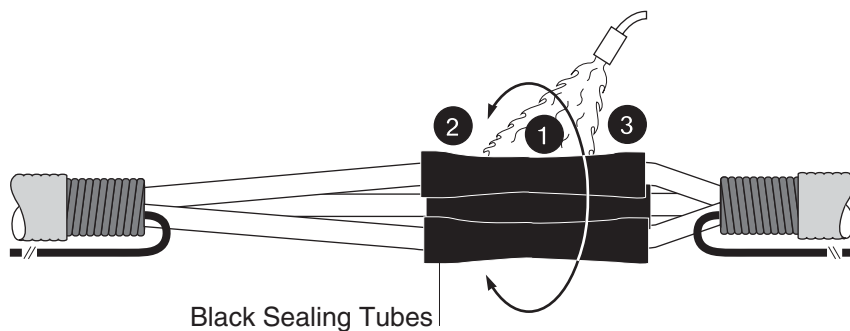

2014

## 5-8kV Shielded

### 13. Abrade insulation.

Abrade the insulation, if necessary, to remove imbedded semi-con and clean as shown.

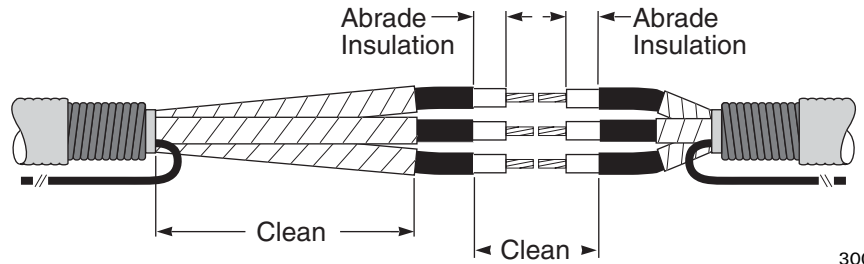

### 14. Place tubes over phases.

Place one black/red dual layer tube over each phase as shown.

Protect tubes from end of conductor as they are placed over cable end.

Discard re-jacketing tubes from 1/C kits.

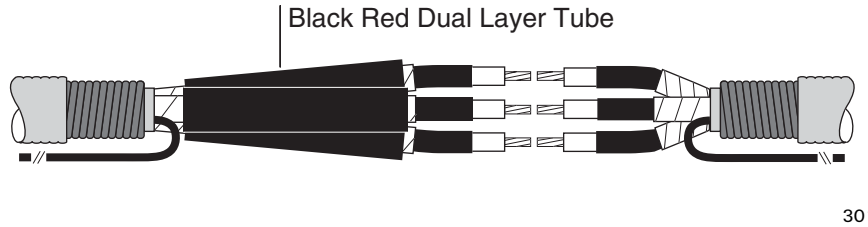

### 15. Install connectors.

After installation, deburr connectors.

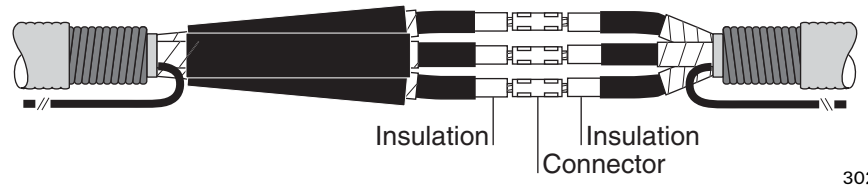

### 16. Apply SRM over connector.

Complete Steps 16-19 working on one phase at a time.

Clean connector area and insulation, as shown, using an oil-free solvent.

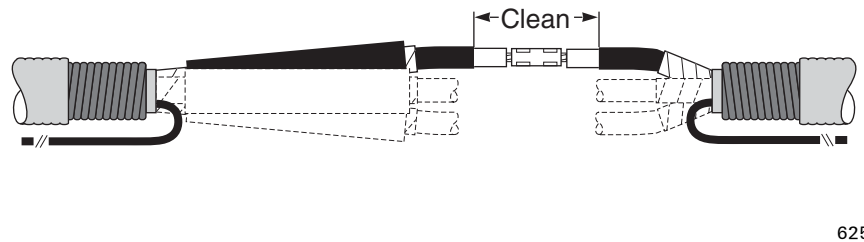

Remove backing from one side of the *long strip* of Stress Relief Material (SRM). Roll the SRM and remaining backing strip into a convenient size. Remove the remaining backing strip and tightly wrap the SRM around the connector and exposed conductor. Be sure to fill the gaps and low spots around the connector.

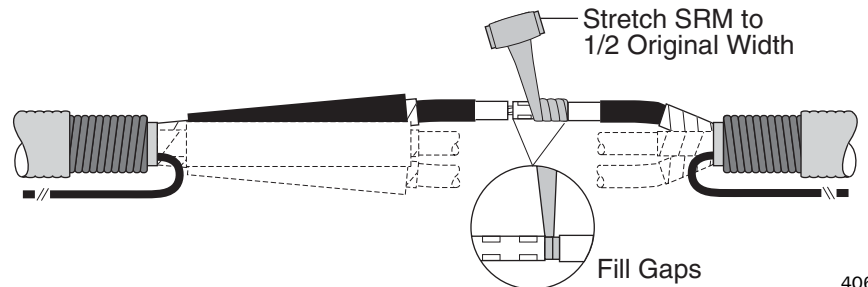

Continue to wrap SRM onto the solvent cleaned insulation as shown.

**Note:** If connector diameter is larger than insulation diameter, apply two half-lapped layers of SRM over the entire connector. Discard any excess SRM (long strips).

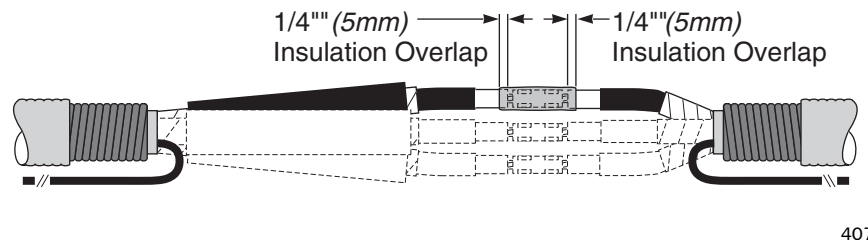

### 17. Apply SRM at semi-con cutback.

Remove backings from the *short angle-cut piece* of SRM. Place tip of SRM at semi-con cutback and tightly wrap to fill semi-con step. Overlap semi-con and insulation as shown. Taper SRM down to meet insulation.

**Note:** If using UniShield cable, apply SRM as shown to fill conductive jacket step.

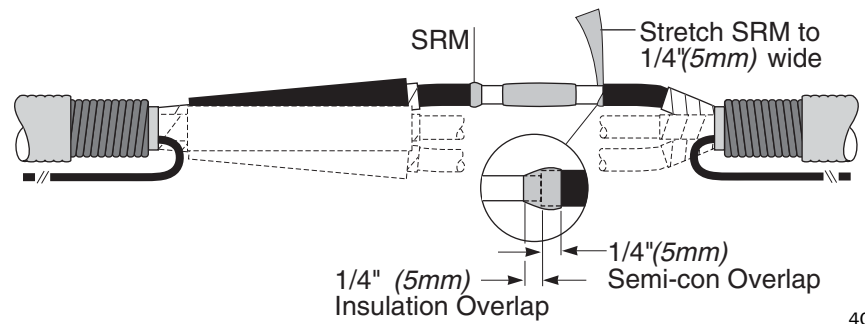

408

### 18. Apply red sealant.

Remove the backing from the red sealant and place one complete wrap onto the cable semi-con 1/2" (13mm) from the edge of the SRM as shown.

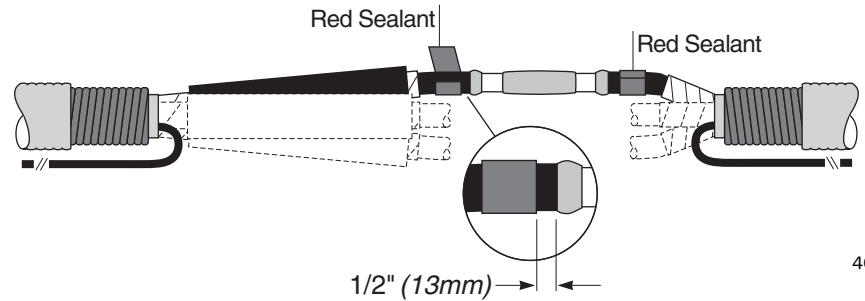

409

### 19. Position tube over connection.

Center black/red dual layer tube over completed connector area.



**Repeat Steps 16-19 on the remaining phases.**

410

### 20. Check position of tubes; shrink in place.

Make sure each tube is centered over the connection area. Shrink all three tubes in place at the same time.

Begin shrinking at center of tube (1), working torch with a smooth, brushing motion around the tube. After center portion shrinks, work torch as before toward one end (2), then to the opposite end (3). Apply sufficient heat to ensure softening of the SRM, indicated by a smooth surface profile.

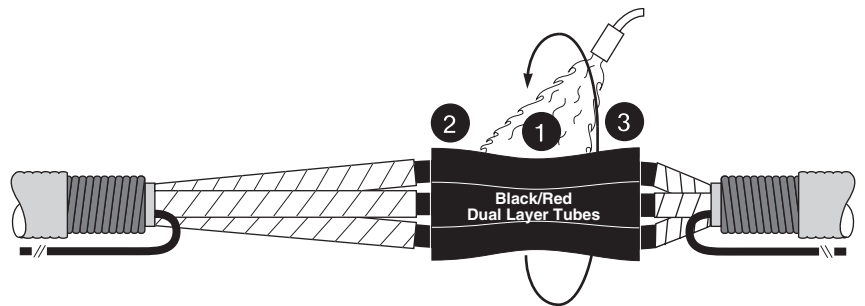

411

**Skip to Step 31, Page 12.**



## 15kV, 25kV, 35kV Cables

### 21. Abrade insulation.

Abrade the insulation, if necessary, to remove imbedded semi-con and clean as shown.

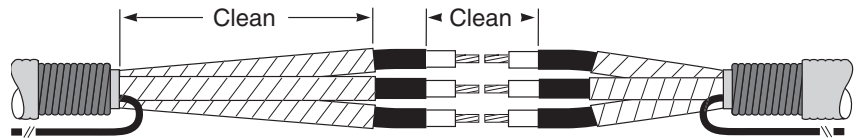

688

### 22. Place nested tubes over phases.

Place one set of nested tubes over each phase as shown.

Protect tubes from end of conductor as they are placed over cable end.

Discard re-jacketing tubes from 1/C kits.

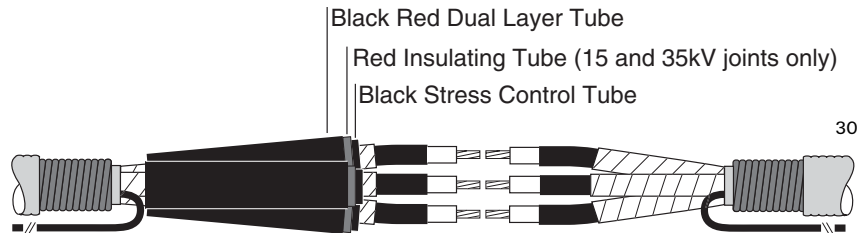

3080

### 23. Install connector.

After installation, deburr connector.

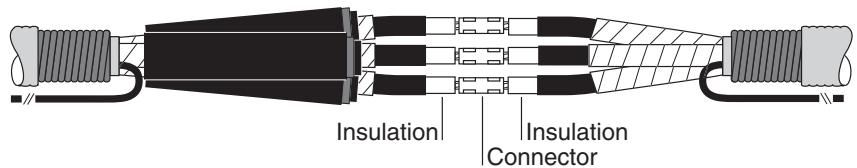

665

### 24. Apply SRM over connector.

Complete Steps 24-26 working on one phase at a time.

Clean connector area and insulation, as shown, using an oil-free solvent.

Remove backing from one side of the *long strip* of Stress Relief Material (SRM). Roll the SRM and remaining backing strip into a convenient size. Remove the remaining backing strip and tightly wrap the SRM around the connector and exposed conductor. Be sure to fill the gaps and low spots around the connector.

Continue to wrap SRM onto the solvent cleaned insulation as shown.

**Note:** If connector diameter is larger than insulation diameter, apply two half-lapped layers of SRM over the entire connector. Discard any excess SRM (long strips).

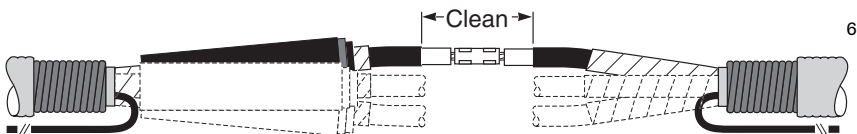

666

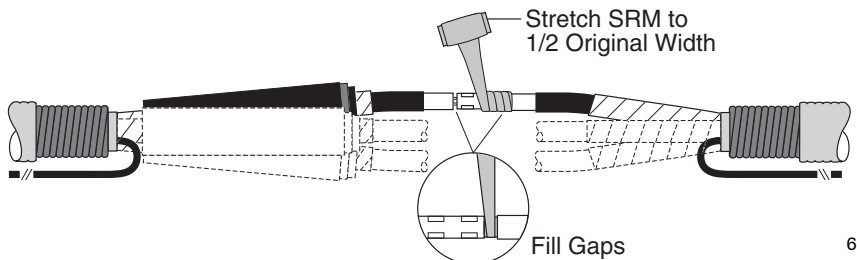

667

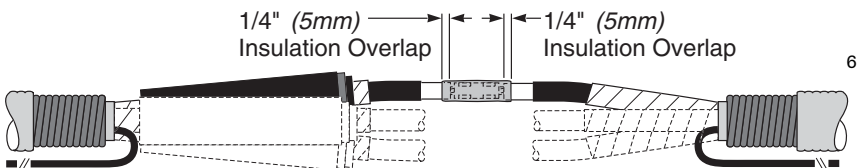

668

## 25. Apply SRM at semi-con cutback.

Remove backings from the *short angle-cut piece* of SRM. Place tip of SRM at semi-con cutback and tightly wrap to fill semi-con step. Overlap semi-con and insulation as shown. Taper SRM down to meet insulation.

**Note:** If using UniShield cable, apply SRM as shown to fill conductive jacket step.

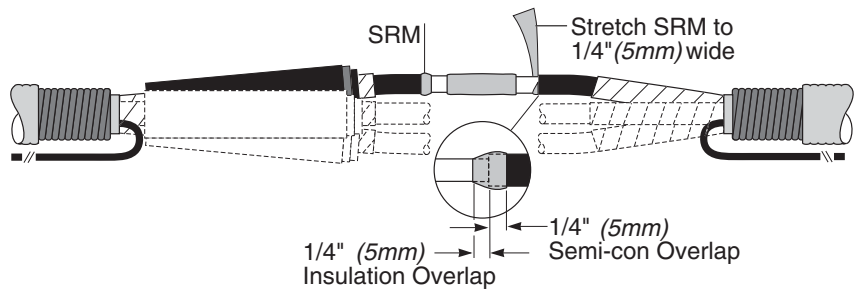

669

## 26. Apply Discharge Control Compound (DCC).

Snip open the end of the DCC ampule and apply a thin film of compound on the SRM over the connector and semi-con steps. Repeat on other two phases.

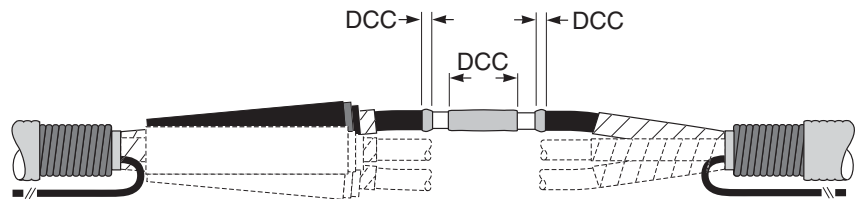

669A

## 27. Position tube over connection.

Center black stress control tube over completed connector area.

**Repeat Steps 24-27 on the remaining phases.**

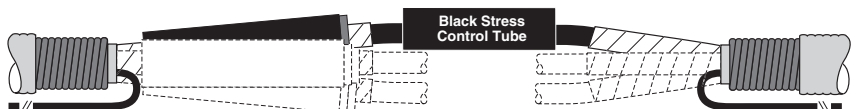

670

**28. Check position of Black Stress Control tubes; shrink in place.**

Center the tubes over the splice. Begin shrinking at the center (1) of the tubes, working the torch around all sides of the tubes. After the center portion shrinks, work towards one end (2), then to the opposite end (3).

**Note:** Do not point the flame at the cable semi-con.

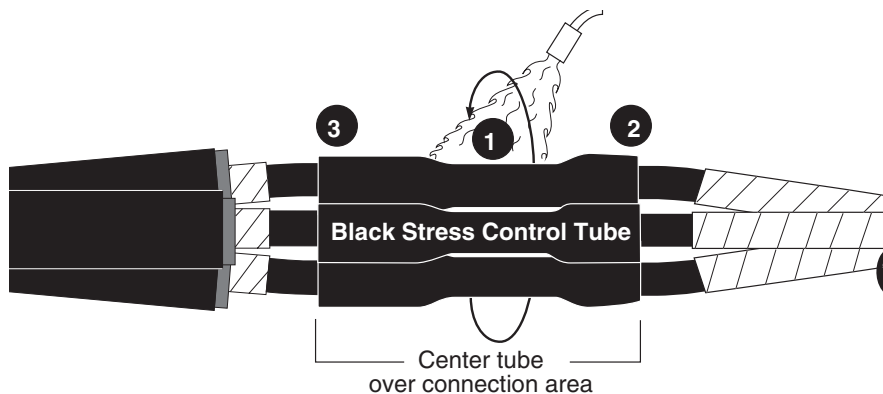

The rings from the SRM wraps may be visible as the tubing shrinks.

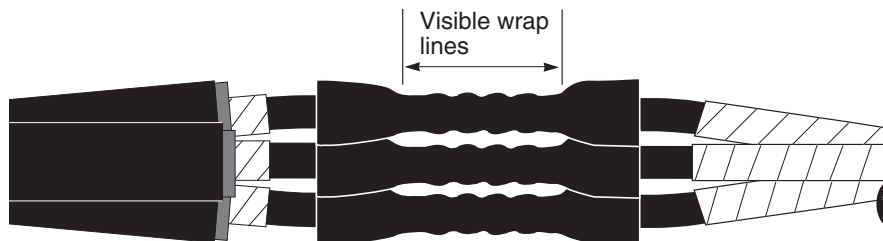

Post heat the connector area until the tube surface is smooth and the underlying SRM wraps are no longer visible.

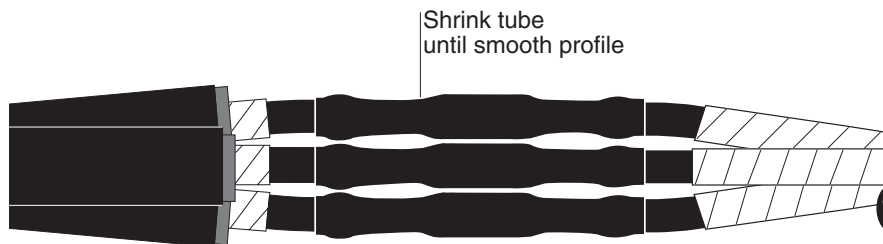

671

**29. (15kV and 35kV joints only) Position Red Insulating tubes; shrink in place.**

Center the red insulating tubes over the black stress control tubes. Shrink all three tubes in place at the same time, using the same method as in Step 28.

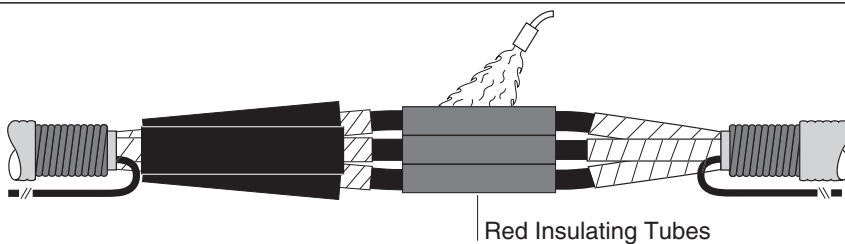

672

**30. Apply red sealant.**

Remove backing from red sealant. Using light tension, wrap sealant over each cable phase, butted against the tubes as shown. Build the sealant to the level of the previously installed tube.

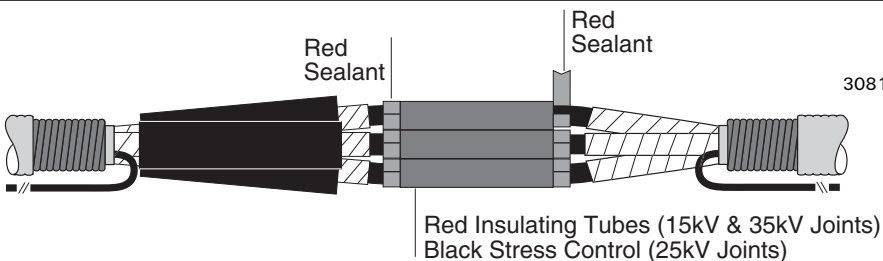

3081

**31. Position Black/Red Dual Layer tubes; shrink in place.**

Center black/red dual layer tubes over previously installed tubes. Make sure tubes extend over sealant at both ends.

Choose the shrinking procedure below based on voltage class.

**A. For 5-15kV installations**

Shrink all three tubes at once. Begin shrinking in center of tubes, working torch around all sides of the tubes. *Pay particular attention to the back and underside of the tubes.* After center portion shrinks, work torch as before toward one end, then to the opposite end.

Post heat for 1 minute.

**Go to Step 32, Page 13.**

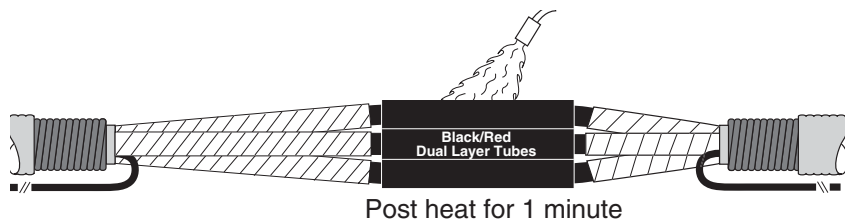

674

**B. For 25-35kV installations**

Center tubes over joint.

(1) Begin shrinking in center of tubes, working torch around all sides of the tubes. *Pay particular attention to the back and underside of the tubes.*

(2) Before continuing, gently twist the unshrunk end of the tubes to feel for resistance to movement in center indicating the center is shrunk.

(3) Shrink from the center toward one end and stop about 5" (125mm) from the end of the tubes.

(4) Return to the center and shrink toward the other end, again stopping about 5" (125mm) from the end of the tubes.

(5) Go back to first end and shrink the remaining 5" (125mm) of tubes.

(6) Go back to second end and shrink the remaining 5" (125mm) of tubes.

(7) After completing these steps, heat the entire tubes for approximately 1 minute.

**Note:** (8) The raised ridges should disappear. Absence of ridges can be observed by visual inspection and by feeling surface with a gloved hand.

**Go to Step 32, Page 13.**

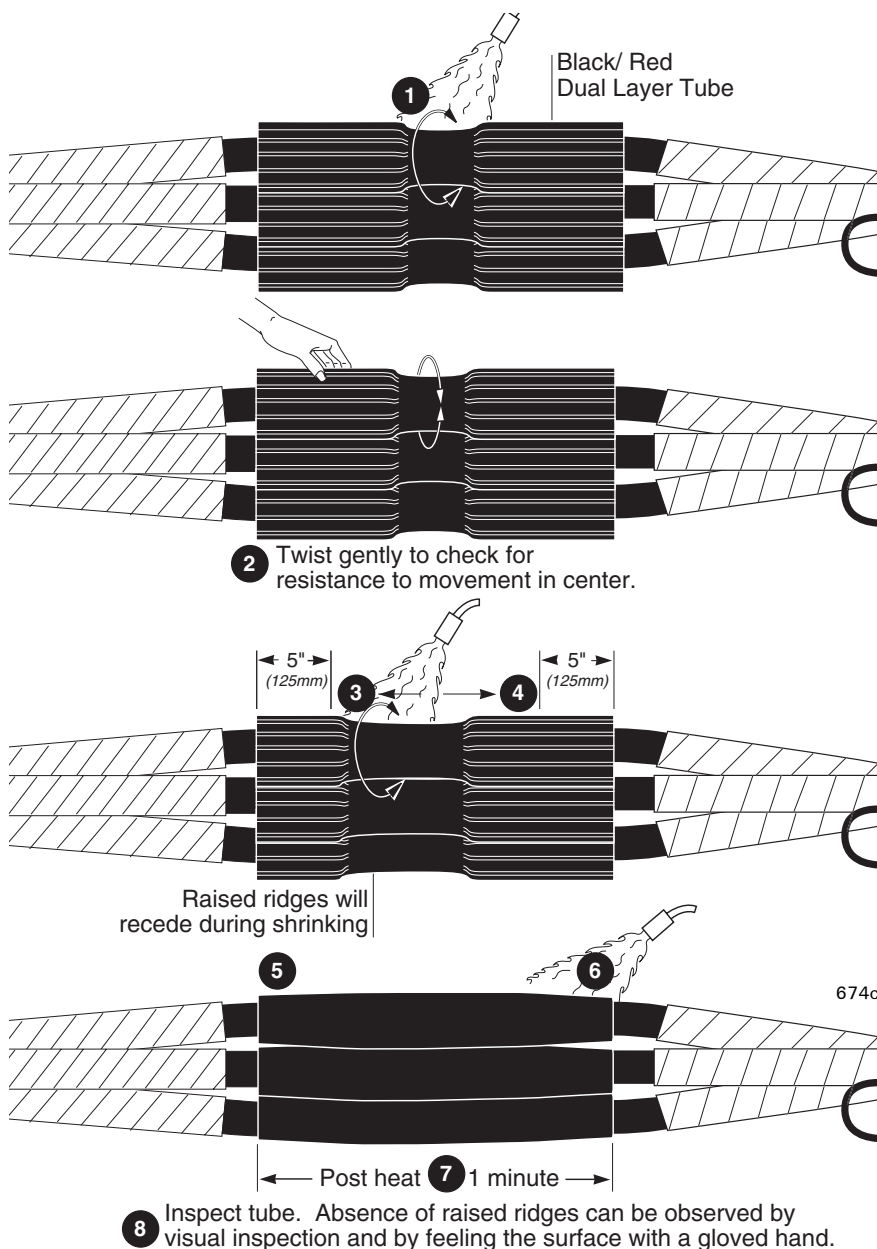

674c

### 32. Install ground.

Choose the appropriate cable type (Choice 1 or 2) and follow the directions given.

### Note: If External Grounding or Shield Interrupting

Refer to Tyco Electronics HVS-EG, "Guide for External Grounding and Shield Interrupting of Power Cable Splices" for modifications to these instructions.

#### CHOICE 1

#### If Metallic Tape Shield Cable

(1) Flare one end of the ground braid and place it onto the metallic tape butted up to the installed splice tube. (2) Attach the braid to the shield by placing two wraps of the spring clamp over the braid. (3) Fold the braid back over the spring clamp wraps. Continue to wrap the remaining clamp over the braid. Tighten clamp by twisting it in the direction it is wrapped and secure with copper foil tape provided.

(4) Lay the braid across the splice tube and onto the exposed tape shield on the other side. (5) Make two wraps of the clamp over the braid. (6) Fold the braid back toward the splice and finish wrapping the clamp. Tighten and secure. Cut off excess braid. Repeat Choice 1 for remaining phases.

Discard connectors.

Go to Step 33.

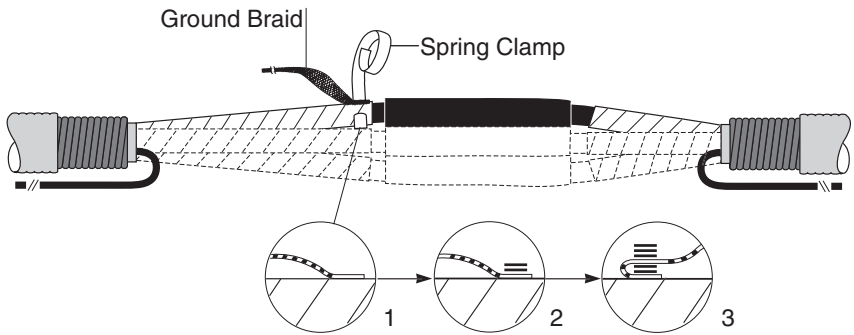

675

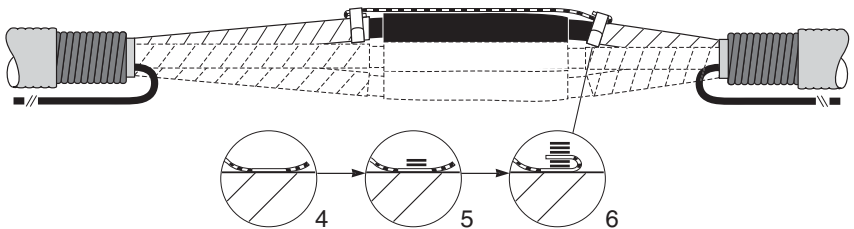

689

## CHOICE 2

### If Drain Wire or UniShield Cable

Pigtail the wires on each side. Crimp the ground braid onto one pigtail with the connector provided.

Lay braids across splice tubes and attach to pigtail on the other side. Cut off excess braid and trim pig-tailed wires. Repeat Choice 2 for remaining phases.

Discard spring clamps and foil tape.

Go to Step 33.

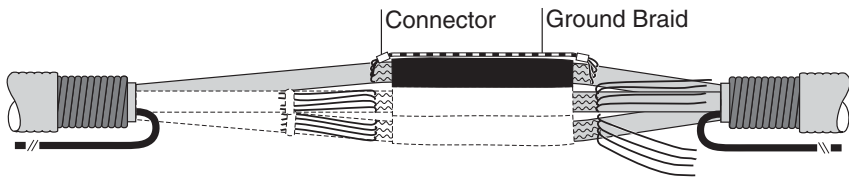

690

### 33. Connect grounding conductor(s).

Bend the grounding conductor(s) back over the tubes and splice with a suitable connector.

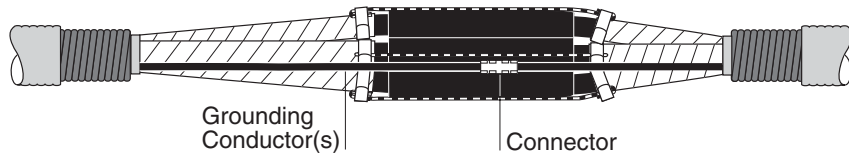

691

### 34. Install the shielding mesh for shielded cables.

Starting on the cable shields, wrap a half-lapped layer of the mesh around all three phases across the length of the the tubes and tie off on the shields at the other side of the splice.

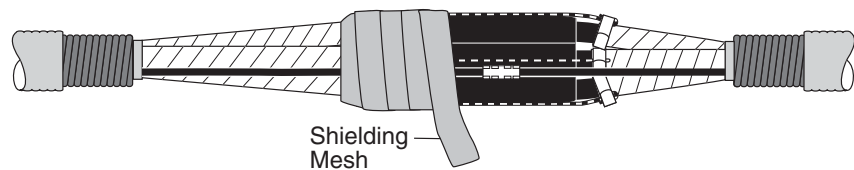

692

### 35. Install armorwrap.

Position armorwrap around splice area and center on the exposed cable armor.

Bind the ends of the armorwrap to the cable armor and secure with the tape provided.

Abrade and solvent clean cable jackets as shown to provide an oil-free surface.

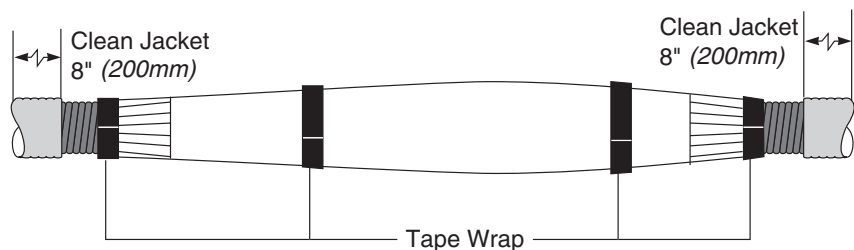

693

### 36. Apply sealant.

Apply one wrap of black sealant starting at the jacket cutbacks around both cable jackets as shown.



693a

### 37. Position wraparound sleeve.

Remove or tape over all sharp points to prevent puncture of wraparound sleeve. Remove backing from wraparound sealing sleeve and center sleeve over splice. Slide metal retention clip onto the butted rails.

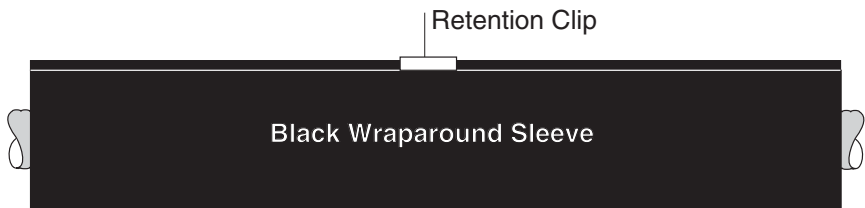

2578

### 38. Install channel clip.

Connect the channels by overlapping the retention clip as shown at right.

**Note:** Channels must overlap sleeve edge by 1/4 inch (5mm) minimum.

**If channels slide on easily go to step 39. If channel fit seems tight, continue with next paragraph.**

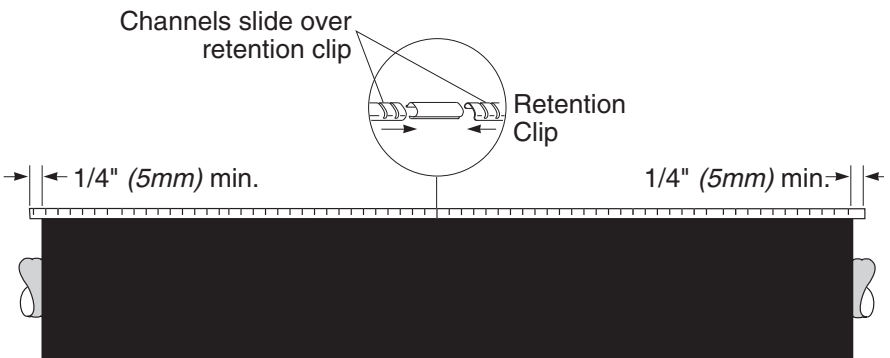

686

As shown in illustration A, make sure flap is not pinched between the rails. Push the sleeve up from the bottom and down from the top while sliding on channel as shown in illustration B. The idea is to flatten the rails together to prevent the channels from binding.

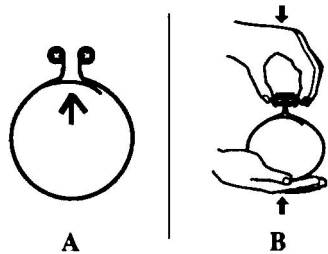

### 39. Shrink the wraparound sleeve.

Preheat evenly along both sides of the rail/channel area until this area begins to shrink. To achieve uniform heating, move the flame back and forth from one side of the channel to the other as shown in illustration "A" **while** moving flame along the entire length of the channel as shown in illustration "B" until the sleeve starts to shrink. This technique will assure a properly preheated rail and channel area.

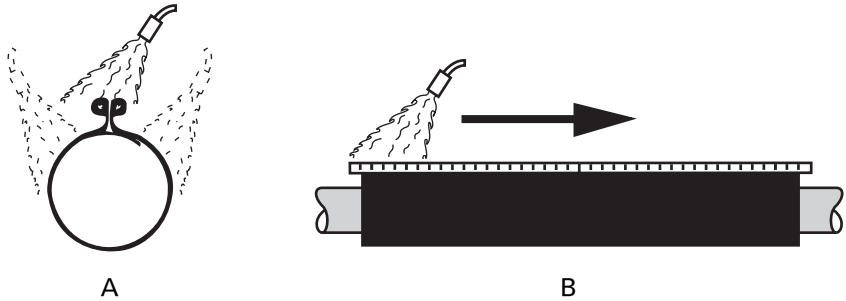

Begin shrinking at the center of the sleeve and work toward each end. Apply heat until the sleeve is fully shrunk and the heat-sensitive green paint is completely converted to black. Continue heating the rail/channel area for another 5 seconds per foot. A white line should be visible in the channel gaps indicating sufficient heating.

**Note: Green heat-sensitive paint will turn black as sleeve shrinks in place.**

**This completes the splice.**

**Note:** Allow to cool before moving or placing in service.

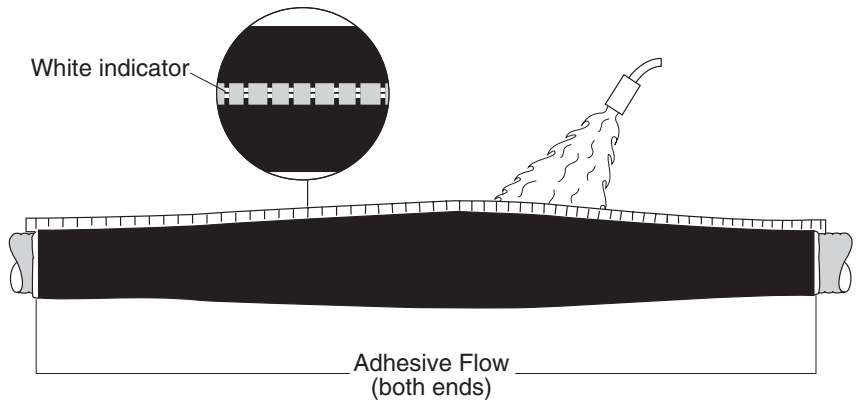

687

The Information contained in these installation instructions is for use only by installers trained to make electrical power installations and is intended to describe the correct method of installation for this product. However, Tyco Electronics has no control over the field conditions which influence product installation. It is the user's responsibility to determine the suitability of the installation method in the user's field conditions. Tyco Electronics' only obligations are those in Tyco Electronics' standard Conditions of Sale for this product and in no case will Tyco Electronics be liable for any other incidental, indirect or consequential damages arising from the use or misuse of the products. Raychem is a trade mark of Tyco Electronics Corporation.