

fiberglass BOX™

ISSUE DATE: 05/13/2015

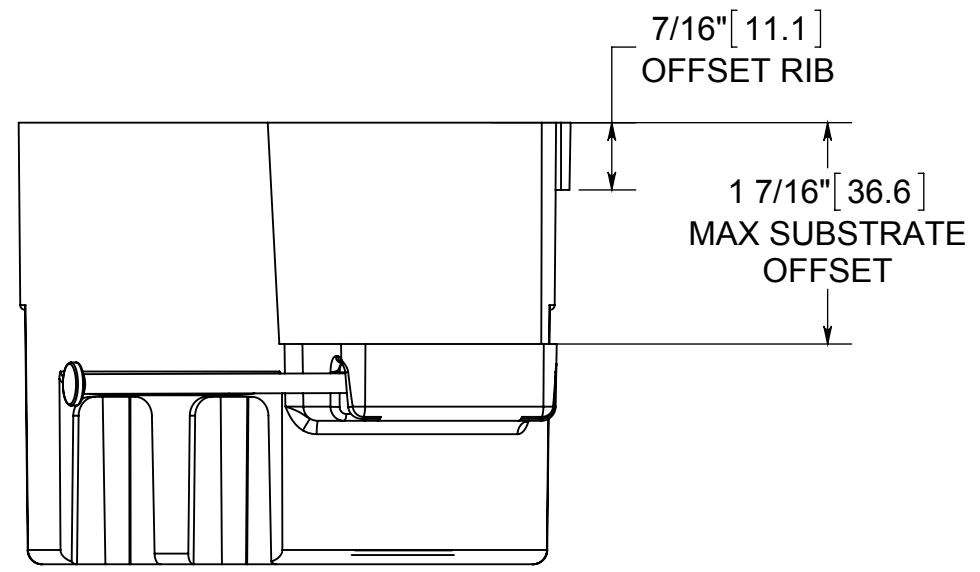
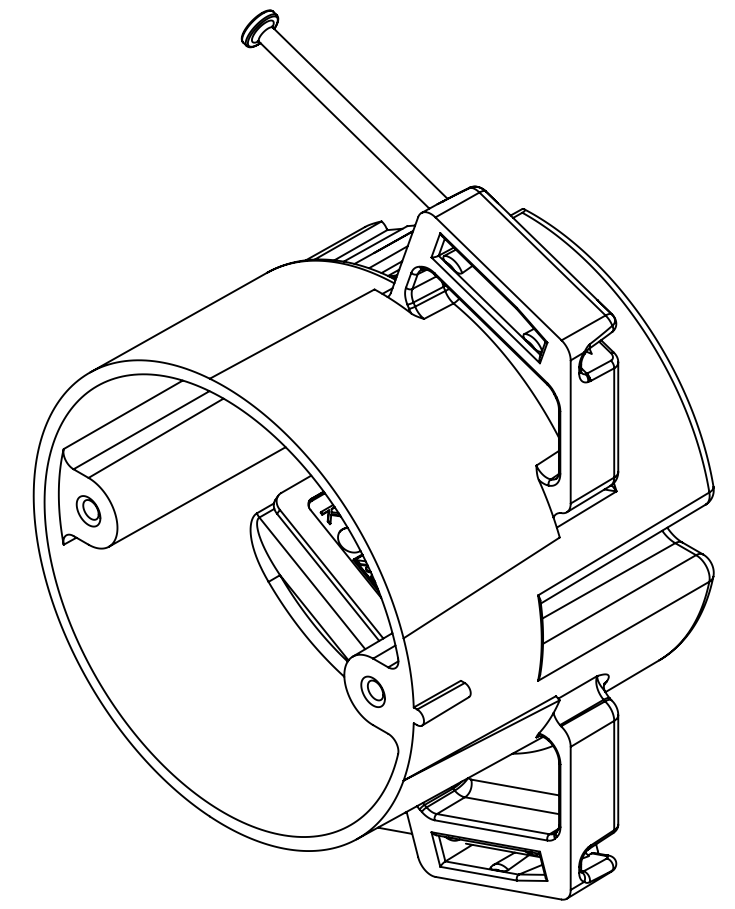
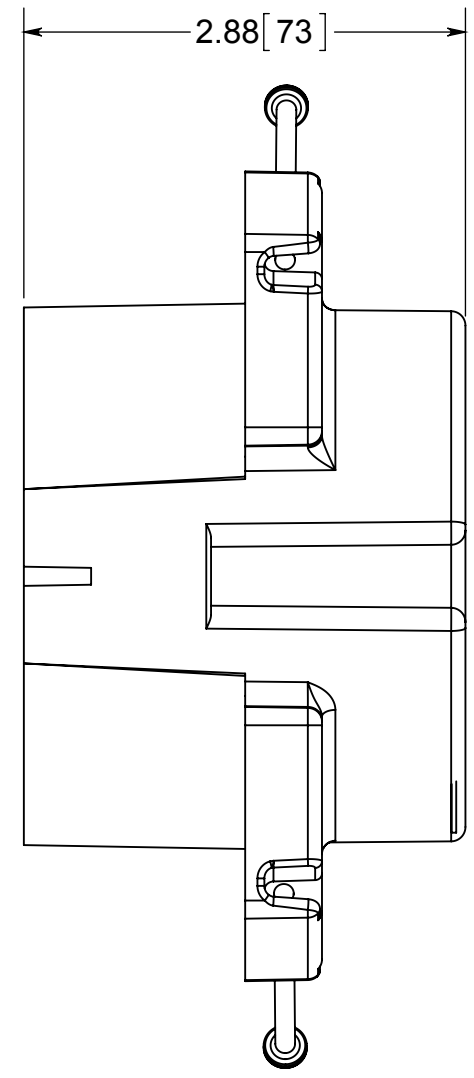
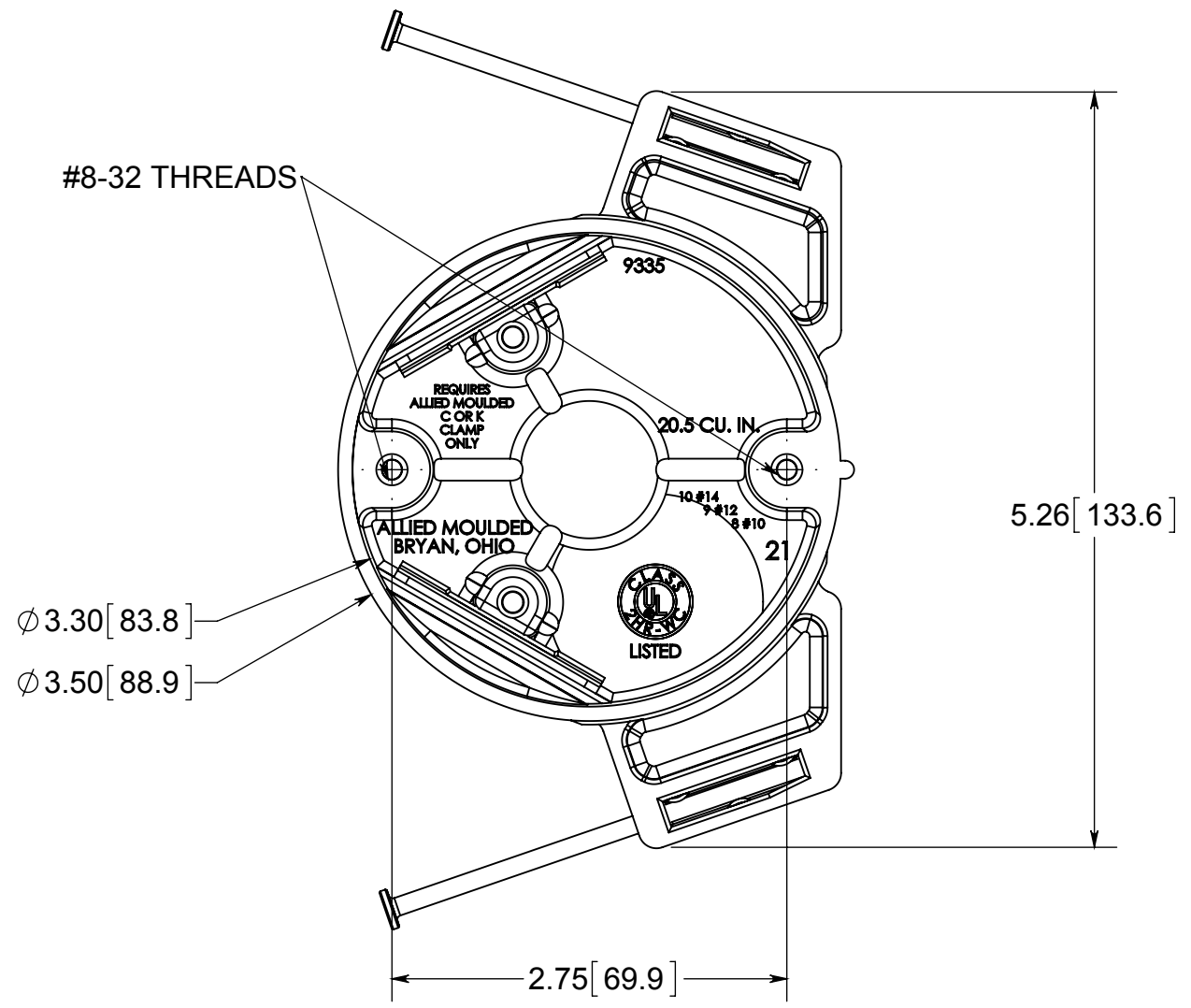

- NOTES:
- 1.) BOX MATERIAL: FIBERGLASS REINFORCED POLYESTER, NAIL MATERIAL: PLATED CARBON STEEL, SPEED KLAMP MATERIAL: PVC
 - 2.) UL LISTED WITH 2 HOUR FIRE RATING FOR WALL AND CEILING
 - 3.) ANGLED MID-NAILED
 - 4.) 2 SPEED KLAMPS FACTORY INSTALLED

 **ALLIED MOULDED PRODUCTS**
BRYAN, OHIO
The Original Fiber Glass Outlet Box

PRODUCT SERIES
3-1/2" ROUND 20.5 CU. IN.

Part No.
9335-NK

CONFIDENTIAL
THIS MATERIAL IS OWNED BY THE ALLIED MOULDED PRODUCTS COMPANY, IS DISCLOSED IN CONFIDENCE, AND IS NOT TO BE REPRODUCED OR DISTRIBUTED WITHOUT PRIOR WRITTEN PERMISSION FROM ALLIED MOULDED PRODUCTS.