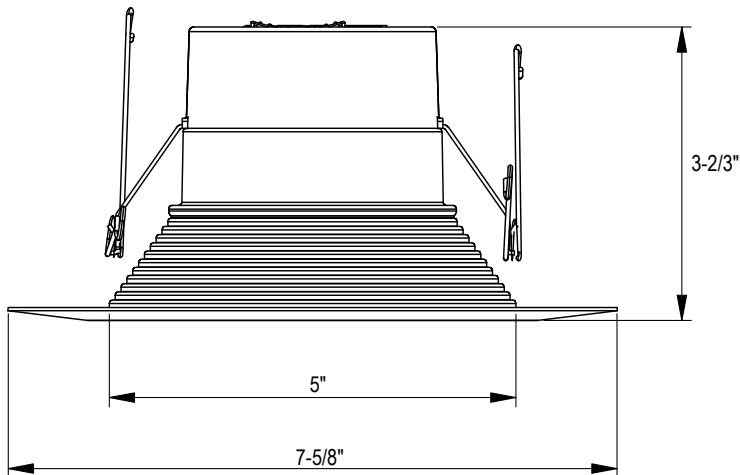

JUNO[®]**E Series LED Downlight Retrofit**

5"/6" Switchable White LED Retrofit Module

65BE/65SE SWW5 Series**Dimensions**

Ships with:

**E26 Adapter**

Project:
Fixture Type:
Location:
Contact/Phone:

Product Features

The 5"/6" recessed LED module is the most economical means to create a well lit environment with exceptional energy efficiency and near zero maintenance. Great for retrofit into existing downlight cans or new construction and remodel applications. The LED module maintains at least 70% light output for 50,000 hours.

- 5 switchable white color temperatures to choose from via switch; 2700K, 3000K, 3500K, 4000K, 5000K CCT; 90 CRI
- Lumens: 900L standard, 1200 w/ HL option
- Adjustable torsion spring allows fitment into many 5" and 6" cans
- Baffle or smooth trim options with designer color finish trim inserts (sold separately)

Applications

- Retrofit into existing downlight cans or new and remodel construction in residential and light commercial applications
- Suitable for installation in standard and shallow-height rough-in sections
- Wet rated and air-loc: perfect for showers, bathrooms, and outdoor soffits

Performance

Delivered Lumens	Nominal 900L; 1200L at 3000K
LED Color Temperature	Switchable White (2700K, 3000K, 3500K, 4000K, 5000K) Default set at 3000K
CRI	90+
Voltage	Dedicated 120V
Dimming	Dimmable flicker-free dimming from 100% to 10%

For a list of compatible dimmers see JUNOESERIES-DIM

Specifications

Aperture:	5"
Ceiling opening:	5.25"
Overlap trim:	7.62"
Height:	3.67"



E Series LED Downlight Retrofit

5"/6" Switchable White LED Retrofit Module



ORDERING INFORMATION

Downlight

Example: 65BEMW SWW5 90CRI

Series	LED	Color Temperature	Rendering Index
65BEMW 6" Juno E Series Baffle Retrofit Downlight	(Blank) Low Lumen (900L)	SWW5 Switchable White (2700K, 3000K, 3500K, 4000K, 5000K)	90CRI 90+ CRI
65SEMW 6" Juno E Series Smooth Retrofit Downlight			
65BEMW 6" Juno E Series Baffle Retrofit Downlight	HL ¹ Hi Lumen (1200L)		

Notes
1. Hi Lumen only available in baffle option

Housing options : Order as separate catalog number.			
QC6 Quick Connect 6" LED new construction downlight	LCS 6" new construction housing	IC21 6" IC shallow new construction housing	
QC6R Quick Connect 6" LED Remodel Downlight	LCP 6" new construction shallow housing	IC21R 6" IC shallow remodel housing	
L7X 6" new construction housing	L5 5" new construction housing	IC22 6" IC new construction housing	
L7XR 6" remodel housing	L5R 5" remodel housing	IC22R 6" IC remodel housing	
L7XP 6" new construction shallow housing		IC23 6" IC new construction housing, no plate	
L7XPR 6" remodel shallow housing		IC23R 6" IC remodel housing, no plate	

Accessories: Order as separate catalog number.	
TSA6 J6 6" torsion spring adaptor (pack of 6)	
LEDRETROWHIP Replacement E26 screw base adapter for installation into incandescent housings	

Pairs perfectly with Juno housings for a complete downlight solution: Order housings as separate catalog number.

QC6 Series - New Construction Quick Connect LED Housing

QC6R Series - New Construction Quick Connect LED Housing



TRIM INSERTS

TRIM INSERTS (for field configuration; ordered separately)

Example: 65SEBN R4

Series/Finish	Packaging
65BEMB 6" Baffle, Matte Black	R4 Retail Pack of 4 units
65BEBN 6" Baffle, Matte Nickel	
65BEORB 6" Baffle, Oil-Rubbed Bronze	
65SEMB 6" Smooth, Matte Black	
65SEBN 6" Smooth, Brush Nickel	
65SEORB 6" Smooth, Oil-Rubbed Bronze	

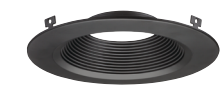

6" Baffle, Matte Black (65BEMB)

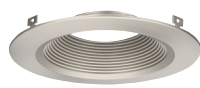

6" Baffle, Brush Nickel (65BEBN)

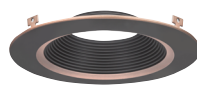

6" Baffle, Oil-Rubbed Bronze (65BEORB)



6" Smooth, Matte Black (65SEMB)



6" Smooth, Brush Nickel (65SEBN)



6" Smooth, Oil-Rubbed Bronze (65SEORB)



Pre-Install color finish trim insert over white 6" E Series Module.



Press down color finish tabs for post-installation to create final LED 6" module.



E Series LED Downlight Retrofit

5"/6" Switchable White LED Retrofit Module



Specifications

LED Downlight Retrofit Trim

Aluminum spun reflector with deep regression for reduced glare • Inner reflector cone funnels light through the pressed-in diffused lens • All-in-one design where LED light engine mounts directly to trim for ease of installation into existing 5" or 6" recessed housings with medium base sockets • Provided with torsion springs.

LED Light Engine

LEDs are mounted directly to aluminum housing providing superior thermal management to ensure long life • Switchable white LED color temperature technology offers 2700K, 3000K, 3500K, 4000K, 5000K all in one trim • 90 CRI minimum • Accommodates 120 volts DC at 60Hz • Dimmable with most standard incandescent, magnetic low voltage and electronic low voltage dimmers • For a list of compatible dimmers, see JUNOESERIES-DIM.

Electrical Connections

Trim features quick connect plug installed as standard for installation into LEDT24 housings with mating connector • Trim ships with a medium base socket adapter whip for installation into 5" or 6" incandescent housings with medium base sockets.

Optical System

Diffused lens at end of mixing chamber to provide even light distribution for general illumination • 900L is equivalent to 75W BR30 lamp • 1200L is equivalent to 120W PAR30 lamp.

Designer Color Finish Trim Inserts (sold separately)

Color Finish Trim inserts are accessory rings that attach to the 65BE/65SE module for a permanent finish. The finishes are available in Baffle or Smooth option:

- Black
- Brush Nickel
- Oil-Rubbed Bronze

Life

Rated for 50,000 hours at 70% lumen maintenance.

Labels

CSA certified to US and Canadian safety standards • ENERGY STAR® certified product • Suitable for wet location • Air-Loc certified in accordance with ASTM E283-2004 • NOM Certified • Can be used to comply with California Title 24 Part 6 High Efficacy LED light Source Requirements • T20 Certified.

Testing

All reports are based on published industry procedures; field performance may differ from laboratory performance.

Warranty 5-year limited warranty. This is the only warranty provided and no other statements in this specification sheet create any warranty of any kind. All other express and implied warranties are disclaimed. Complete warranty terms located at:

www.acuitybrands.com/CustomerResources/Terms_and_conditions.aspx

Specifications subject to change without notice.

PERFORMANCE DATA

	65BE/65SE 900L	65BE/1200L
Input Voltage	120V	120V
Input Power Typical	10.5W (+/-5%)	13.9W (+/-5%)
Power Factor	.9	.9
Frequency	60 Hz	60 HZ
EMI/RFI	FCC Title 47, Part 15 Class B (consumer)	FCC Title 47, Part 15 Class B (consumer)
Minimum Starting Temp	-20°C (-4°F) minimum	-20°C (-4°F) minimum

Note: Actual performance may differ as a result of end-user environment and application. All values are design or typical values, measured under laboratory conditions at 25°C.

65BEMW HL SWW5 90CRI M6

LIGHTING PERFORMANCE DATA DONNÉES SUR LE RENDEMENT DE L'ÉCLAIRAGE	
Light Appearance (CCT) Aspect de la lumière (CCT)	
2700K soft white blanc doux	1160 lumens 88 lumens per watt
3000K warm white blanc chaud	1190 lumens 87 lumens per watt
3500K neutral white blanc neutre	1203 lumens 87 lumens per watt
4000K cool white blanc froid	1216 lumens 86 lumens per watt
5000K daylight blanc neutre	1224 lumens 83 lumens per watt
Watts	13.9
Color Accuracy (CRI) Précision des couleurs (CRI)	90

65BEMW SWW5 90CRI M6

LIGHTING PERFORMANCE DATA DONNÉES SUR LE RENDEMENT DE L'ÉCLAIRAGE	
Light Appearance (CCT) Aspect de la lumière (CCT)	
2700K soft white blanc doux	882 lumens 84 lumens per watt
3000K warm white blanc chaud	891 lumens 85 lumens per watt
3500K neutral white blanc neutre	913 lumens 87 lumens per watt
4000K cool white blanc froid	921 lumens 88 lumens per watt
5000K daylight blanc neutre	931 lumens 89 lumens per watt
Watts	10.5
Color Accuracy (CRI) Précision des couleurs (CRI)	90



E Series LED Downlight Retrofit

5"/6" Switchable White LED Retrofit Module



PHOTOMETRICS

Distribution Curve

Distribution Data

Output Data

Coefficient of Utilization

Illuminance Data at 30" Above Floor for a Single Luminaire

65BEMW SWW5 90CRI, 2700K, Input Watts: 10.4, Delivered Lumens: 882, LPW: 84.8, S/MH: 1.15, Test No: ISF 202495P1

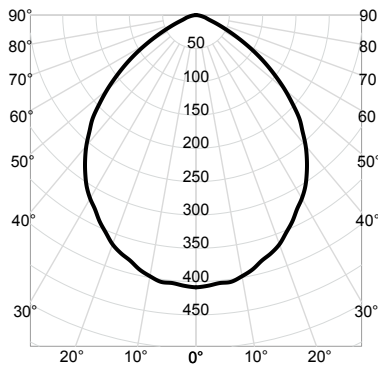

CP Summary	Zonal Lumen Summary				Coefficients of Utilization										Cone of Light			Luminance (cd/sq.m)	
	0°	Zone	Lumens	% Fixture	pw	80%		20%		50%		Mounting Height	Initial FC Center Beam	Beam Diameter	Average Luminance				
						50%	30%	10%	50%	30%	10%					50%	30%	10%	
0°	409	0° - 30°	311	35%	0	119	119	119	116	116	116	111	111	111	6.0	11.4	12.7	0°	31,746
5°	404	0° - 40°	497	56%	1	107	104	100	105	102	99	101	98	96	8.0	6.4	16.9	45°	24,093
15°	382	0° - 60°	800	91%	2	96	90	85	94	88	84	90	86	82	10.0	4.1	21.1	55°	17,402
25°	342	0° - 90°	882	100%	3	85	78	73	84	77	72	81	75	71	12.0	2.8	25.3	65°	8,524
35°	290	90° - 180°	0	0%	4	77	69	63	75	68	63	73	67	62	14.0	2.1	29.6	75°	4,350
45°	219	0° - 180°	882	100%	5	69	61	55	68	61	55	66	59	54				85°	2,583
55°	128				6	63	55	49	62	54	49	60	53	48					
65°	46				7	57	49	44	57	49	43	55	48	43					
75°	14				8	53	45	39	52	44	39	51	44	39					
85°	3				9	48	41	36	48	40	35	47	40	35					
90°	0				10	45	37	32	44	37	32	43	37	32					

Beam Angle: 93.1°
Field Angle: 136.0°

65BEMW SWW5 90CRI, 3000K, Input Watts: 10.4, Delivered Lumens: 891, LPW: 85.7, S/MH: 1.15, Test No: ISF 202495P2

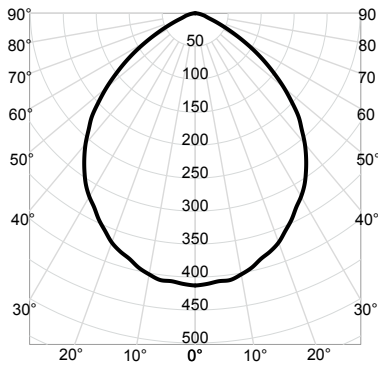

CP Summary	Zonal Lumen Summary				Coefficients of Utilization										Cone of Light			Luminance (cd/sq.m)	
	0°	Zone	Lumens	% Fixture	pw	80%		20%		50%		Mounting Height	Initial FC Center Beam	Beam Diameter	Average Luminance				
						50%	30%	10%	50%	30%	10%					50%	30%	10%	
0°	413	0° - 30°	314	35%	0	119	119	119	116	116	116	111	111	111	6.0	11.5	12.7	0°	32,070
5°	408	0° - 40°	502	56%	1	107	104	100	105	102	99	101	98	96	8.0	6.4	16.9	45°	24,339
15°	385	0° - 60°	808	91%	2	96	90	85	94	88	84	90	86	82	10.0	4.1	21.1	55°	17,580
25°	345	0° - 90°	891	100%	3	85	78	73	84	77	72	81	75	71	12.0	2.9	25.3	65°	8,611
35°	293	90° - 180°	0	0%	4	77	69	63	75	68	63	73	67	62	14.0	2.1	29.6	75°	4,394
45°	222	0° - 180°	891	100%	5	69	61	55	68	61	55	66	59	54				85°	2,610
55°	130				6	63	55	49	62	54	49	60	53	48					
65°	47				7	57	49	44	57	49	43	55	48	43					
75°	15				8	53	45	39	52	44	39	51	44	39					
85°	3				9	48	41	36	48	40	35	47	40	35					
90°	0				10	45	37	32	44	37	32	43	37	32					

Beam Angle: 93.1°
Field Angle: 136.0°

65BEMW SWW5 90CRI, 3500K, Input Watts: 10.4, Delivered Lumens: 913, LPW: 87.8, S/MH: 1.15, Test No: ISF 202495P3

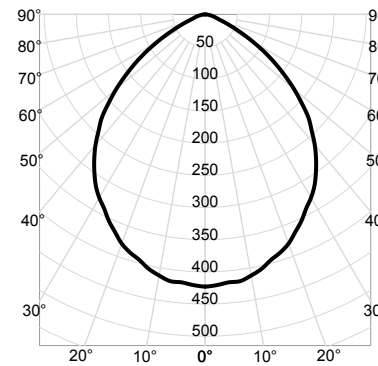

CP Summary	Zonal Lumen Summary				Coefficients of Utilization										Cone of Light			Luminance (cd/sq.m)	
	0°	Zone	Lumens	% Fixture	pw	80%		20%		50%		Mounting Height	Initial FC Center Beam	Beam Diameter	Average Luminance				
						50%	30%	10%	50%	30%	10%					50%	30%	10%	
0°	423	0° - 30°	322	35%	0	119	119	119	116	116	116	111	111	111	6.0	11.8	12.7	0°	32,864
5°	418	0° - 40°	514	56%	1	107	104	100	105	102	99	101	98	96	8.0	6.6	16.9	45°	24,941
15°	395	0° - 60°	828	91%	2	96	90	85	94	88	84	90	86	82	10.0	4.2	21.1	55°	18,015
25°	354	0° - 90°	913	100%	3	85	78	73	84	77	72	81	75	71	12.0	2.9	25.3	65°	8,824
35°	300	90° - 180°	0	0%	4	77	69	63	75	68	63	73	67	62	14.0	2.2	29.6	75°	4,503
45°	227	0° - 180°	913	100%	5	69	61	55	68	61	55	66	59	54				85°	2,674
55°	133				6	63	55	49	62	54	49	60	53	48					
65°	48				7	57	49	44	57	49	43	55	48	43					
75°	15				8	53	45	39	52	44	39	51	44	39					
85°	3				9	48	41	36	48	40	35	47	40	35					
90°	0				10	45	37	32	44	37	32	43	37	32					

Beam Angle: 93.1°
Field Angle: 136.0°



E Series LED Downlight Retrofit

5"/6" Switchable White LED Retrofit Module



PHOTOMETRICS

Distribution Curve

Distribution Data

Output Data

Coefficient of Utilization

Illuminance Data at 30" Above Floor for a Single Luminaire

65BEMW SWW5 90CRI, 4000K, Input Watts: 10.4, Delivered Lumens: 921, LPW: 88.6, S/MH: 1.15, Test No: ISF 202495P4

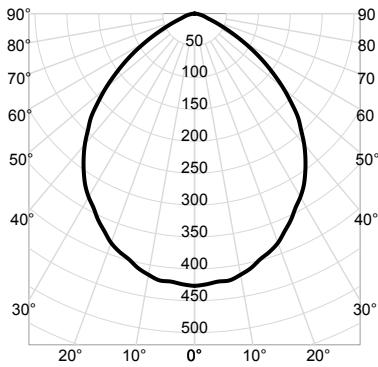

CP Summary		Zonal Lumen Summary				Coefficients of Utilization										Cone of Light			Luminance (cd/sq.m)	
0°	Zone	Lumens	% Fixture	pf	80%		20%		50%		Mounting Height	Initial FC Center Beam	Beam Diameter	Average Luminance						
				pc	50%	30%	10%	50%	30%	10%							50%	30%	10%	
0°	427	0° - 30°	324	35%	0	119	119	119	116	116	116	111	111	111	6.0	11.9	12.7	0°	33,153	
5°	422	0° - 40°	519	56%	1	107	104	100	105	102	99	101	98	96	8.0	6.7	16.9	45°	25,161	
15°	398	0° - 60°	836	91%	2	96	90	85	94	88	84	90	86	82	10.0	4.3	21.1	55°	18,174	
25°	357	0° - 90°	921	100%	3	85	78	73	84	77	72	81	75	71	12.0	3.0	25.3	65°	8,902	
35°	303	90° - 180°	0	0%	4	77	69	63	75	68	63	73	67	62	14.0	2.2	29.6	75°	4,542	
45°	229	0° - 180°	921	100%	5	69	61	55	68	61	55	66	59	54				85°	2,698	
55°	134				6	63	55	49	62	54	49	60	53	48						
65°	48				7	57	49	44	57	49	43	55	48	43						
75°	15				8	53	45	39	52	44	39	51	44	39						
85°	3				9	48	41	36	48	40	35	47	40	35						
90°	0				10	45	37	32	44	37	32	43	37	32						

Beam Angle: 93.1°
Field Angle: 136.0°

65BEMW SWW5 90CRI, 5000K, Input Watts: 10.4, Delivered Lumens: 931, LPW: 89.5, S/MH: 1.15, Test No: ISF 202495P5

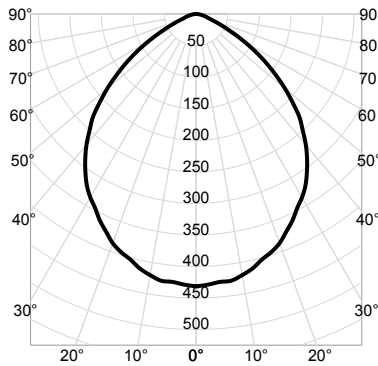

CP Summary		Zonal Lumen Summary				Coefficients of Utilization										Cone of Light			Luminance (cd/sq.m)	
0°	Zone	Lumens	% Fixture	pf	80%		20%		50%		Mounting Height	Initial FC Center Beam	Beam Diameter	Average Luminance						
				pc	50%	30%	10%	50%	30%	10%							50%	30%	10%	
0°	431	0° - 30°	328	35%	0	119	119	119	116	116	116	111	111	111	6.0	12.0	12.7	0°	33,513	
5°	426	0° - 40°	524	56%	1	107	104	100	105	102	99	101	98	96	8.0	6.7	16.9	45°	25,434	
15°	403	0° - 60°	845	91%	2	96	90	85	94	88	84	90	86	82	10.0	4.3	21.1	55°	18,371	
25°	361	0° - 90°	931	100%	3	85	78	73	84	77	72	81	75	71	12.0	3.0	25.3	65°	8,999	
35°	306	90° - 180°	0	0%	4	77	69	63	75	68	63	73	67	62	14.0	2.2	29.6	75°	4,592	
45°	231	0° - 180°	931	100%	5	69	61	55	68	61	55	66	59	54				85°	2,727	
55°	136				6	63	55	49	62	54	49	60	53	48						
65°	49				7	57	49	44	57	49	43	55	48	43						
75°	15				8	53	45	39	52	44	39	51	44	39						
85°	3				9	48	41	36	48	40	35	47	40	35						
90°	0				10	45	37	32	44	37	32	43	37	32						

Beam Angle: 93.1°
Field Angle: 136.0°

65BEMW SWW5 HL 90CRI, 2700K, Input Watts: 14.5, Delivered Lumens: 1230, LPW: 84.8, S/MH: 1.14, Test No: ISF 202133P1

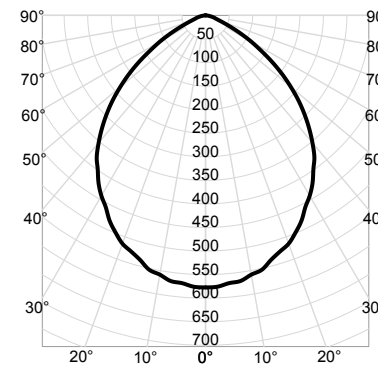

CP Summary		Zonal Lumen Summary				Coefficients of Utilization										Cone of Light			Luminance (cd/sq.m)	
0°	Zone	Lumens	% Fixture	pf	80%		20%		50%		Mounting Height	Initial FC Center Beam	Beam Diameter	Average Luminance						
				pc	50%	30%	10%	50%	30%	10%							50%	30%	10%	
0°	577	0° - 30°	438	36%	0	119	119	119	116	116	116	111	111	111	6.0	16.0	12.3	0°	44,848	
5°	570	0° - 40°	697	57%	1	107	104	101	105	102	99	101	98	96	8.0	9.0	16.4	45°	32,628	
15°	537	0° - 60°	1,118	91%	2	96	90	85	94	89	84	90	86	82	10.0	5.8	20.4	55°	23,364	
25°	481	0° - 90°	1,230	100%	3	86	78	73	84	77	72	81	76	71	12.0	4.0	24.5	65°	11,170	
35°	399	90° - 180°	0	0%	4	77	69	63	76	68	63	73	67	62	14.0	2.9	28.6	75°	5,590	
45°	297	0° - 180°	1,230	100%	5	69	61	55	68	61	55	66	60	55				85°	2,621	
55°	172				6	63	55	49	62	54	49	60	54	48						
65°	61				7	58	49	44	57	49	44	55	48	43						
75°	19				8	53	45	39	52	45	39	51	44	39						
85°	3				9	49	41	36	48	41	36	47	40	36						
90°	0				10	45	38	33	45	37	33	44	37	32						

Beam Angle: 91.3°
Field Angle: 135.8°



E Series LED Downlight Retrofit

5"/6" Switchable White LED Retrofit Module



PHOTOMETRICS

Distribution Curve

Distribution Data

Output Data

Coefficient of Utilization

Illuminance Data at 30" Above Floor for a Single Luminaire

65BEMW SWW5 HL 90CRI, 3000K, Input Watts: 14.5, Delivered Lumens: 1244, LPW: 85.8, S/MH: 1.14, Test No: ISF 202133P2

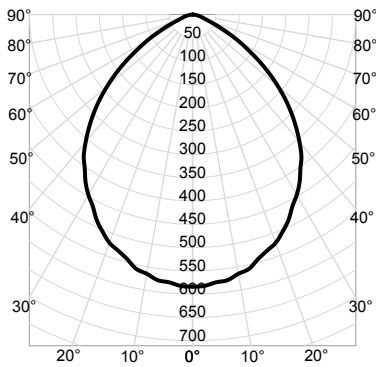

CP Summary		Zonal Lumen Summary				Coefficients of Utilization										Cone of Light			Luminance (cd/sq.m)		
0°	Zone	Lumens	% Fixture	pw	50%	30%	10%	50%	30%	10%	50%	30%	10%	50%	30%	10%	Mounting Height	Initial FC Center Beam	Beam Diameter	Average Luminance	
0°	584	0° - 30°	443	36%	0	119	119	119	116	116	116	111	111	111	111	111	6.0	16.2	12.3	0°	45,359
5°	577	0° - 40°	705	57%	1	107	104	101	105	102	99	101	98	96	96	96	8.0	9.1	16.4	45°	33,000
15°	543	0° - 60°	1,131	91%	2	96	90	85	94	89	84	90	86	82	82	82	10.0	5.8	20.4	55°	23,631
25°	487	0° - 90°	1,244	100%	3	86	78	73	84	77	72	81	76	71	71	71	12.0	4.1	24.5	65°	11,298
35°	403	90° - 180°	0	0%	4	77	69	63	76	68	63	73	67	62	62	62	14.0	3.0	28.6	75°	5,653
45°	300	0° - 180°	1,244	100%	5	69	61	55	68	61	55	66	60	55	55	55				85°	2,651
55°	174				6	63	55	49	62	54	49	60	54	48	48	48					
65°	61				7	58	49	44	57	49	44	55	48	43	43	43					
75°	19				8	53	45	39	52	45	39	51	44	39	39	39					
85°	3				9	49	41	36	48	41	36	47	40	36	36	36					
90°	0				10	45	38	33	45	37	33	44	37	32	32	32					

65BEMW SWW5 HL 90CRI, 3500K, Input Watts: 14.5, Delivered Lumens: 1260, LPW: 86.9, S/MH: 1.14, Test No: ISF 202133P3

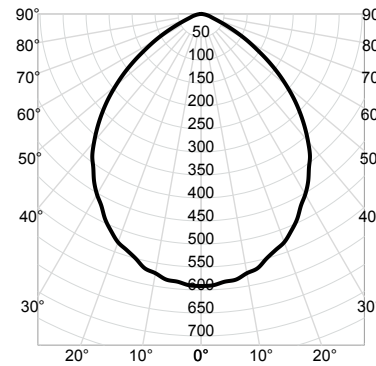

CP Summary		Zonal Lumen Summary				Coefficients of Utilization										Cone of Light			Luminance (cd/sq.m)		
0°	Zone	Lumens	% Fixture	pw	50%	30%	10%	50%	30%	10%	50%	30%	10%	50%	30%	10%	Mounting Height	Initial FC Center Beam	Beam Diameter	Average Luminance	
0°	591	0° - 30°	448	36%	0	119	119	119	116	116	116	111	111	111	111	111	6.0	16.4	12.3	0°	45,944
5°	584	0° - 40°	715	57%	1	107	104	101	105	102	99	101	98	96	96	96	8.0	9.2	16.4	45°	33,425
15°	550	0° - 60°	1,145	91%	2	96	90	85	94	89	84	90	86	82	82	82	10.0	5.9	20.4	55°	23,935
25°	493	0° - 90°	1,260	100%	3	86	78	73	84	77	72	81	76	71	71	71	12.0	4.1	24.5	65°	11,443
35°	409	90° - 180°	0	0%	4	77	69	63	76	68	63	73	67	62	62	62	14.0	3.0	28.6	75°	5,726
45°	304	0° - 180°	1,260	100%	5	69	61	55	68	61	55	66	60	55	55	55				85°	2,685
55°	177				6	63	55	49	62	54	49	60	54	48	48	48					
65°	62				7	58	49	44	57	49	44	55	48	43	43	43					
75°	19				8	53	45	39	52	45	39	51	44	39	39	39					
85°	3				9	49	41	36	48	41	36	47	40	36	36	36					
90°	0				10	45	38	33	45	37	33	44	37	32	32	32					

65BEMW SWW5 HL 90CRI, 4000K, Input Watts: 14.5, Delivered Lumens: 1280, LPW: 88.3, S/MH: 1.14, Test No: ISF 202133P4

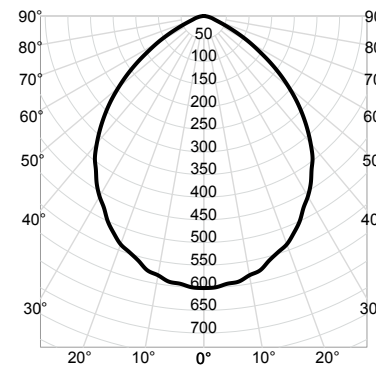

CP Summary		Zonal Lumen Summary				Coefficients of Utilization										Cone of Light			Luminance (cd/sq.m)		
0°	Zone	Lumens	% Fixture	pw	50%	30%	10%	50%	30%	10%	50%	30%	10%	50%	30%	10%	Mounting Height	Initial FC Center Beam	Beam Diameter	Average Luminance	
0°	601	0° - 30°	456	36%	0	119	119	119	116	116	116	111	111	111	111	111	6.0	16.7	12.3	0°	46,674
5°	594	0° - 40°	726	57%	1	107	104	101	105	102	99	101	98	96	96	96	8.0	9.4	16.4	45°	33,956
15°	559	0° - 60°	1,163	91%	2	96	90	85	94	89	84	90	86	82	82	82	10.0	6.0	20.4	55°	24,315
25°	501	0° - 90°	1,280	100%	3	86	78	73	84	77	72	81	76	71	71	71	12.0	4.2	24.5	65°	11,625
35°	415	90° - 180°	0	0%	4	77	69	63	76	68	63	73	67	62	62	62	14.0	3.1	28.6	75°	5,817
45°	309	0° - 180°	1,280	100%	5	69	61	55	68	61	55	66	60	55	55	55				85°	2,728
55°	180				6	63	55	49	62	54	49	60	54	48	48	48					
65°	63				7	58	49	44	57	49	44	55	48	43	43	43					
75°	19				8	53	45	39	52	45	39	51	44	39	39	39					
85°	3				9	49	41	36	48	41	36	47	40	36	36	36					
90°	0				10	45	38	33	45	37	33	44	37	32	32	32					



E Series LED Downlight Retrofit

5"/6" Switchable White LED Retrofit Module



PHOTOMETRICS

Distribution Curve

Distribution Data

Output Data

Coefficient of Utilization

Illuminance Data at 30" Above Floor for a Single Luminaire

65BEMW SWW5 HL 90CRI, 5000K, Input Watts: 14.5, Delivered Lumens: 1290, LPW: 89.0, S/MH: 1.14, Test No: ISF 202133P5

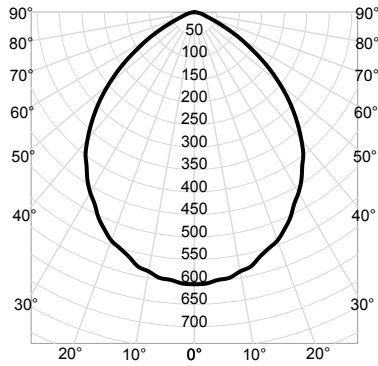

CP Summary		Zonal Lumen Summary				Coefficients of Utilization										Cone of Light			Luminance (cd/sq.m)	
0°		Zone	Lumens	% Fixture	pw	80%		70%		50%		Mounting Height	Initial FC Center Beam	Beam Diameter	Average Luminance					
0°	605	0° - 30°	459	36%	0	119	119	119	116	116	111	111	111	6.0	16.8	12.3	0°	47,039		
5°	598	0° - 40°	732	57%	1	107	104	101	105	102	99	101	98	96	8.0	9.5	16.4	45°	34,222	
15°	563	0° - 60°	1,172	91%	2	96	90	85	94	89	84	90	86	82	10.0	6.1	20.4	55°	24,506	
25°	505	0° - 90°	1,290	100%	3	86	78	73	84	77	72	81	76	71	12.0	4.2	24.5	65°	11,716	
35°	418	90° - 180°	0	0%	4	77	69	63	76	68	63	73	67	62	14.0	3.1	28.6	75°	5,863	
45°	311	0° - 180°	1,290	100%	5	69	61	55	68	61	55	66	60	55				85°	2,749	
55°	181				6	63	55	49	62	54	49	60	54	48						
65°	64				7	58	49	44	57	49	44	55	48	43						
75°	20				8	53	45	39	52	45	39	51	44	39						
85°	3				9	49	41	36	48	41	36	47	40	36						
90°	0				10	45	38	33	45	37	33	44	37	32						

Beam Angle: 91.3°
Field Angle: 135.8°