

AP173018P

ITEM	PART NO.	WT.
ASSEMBLY	AP173018P	187 LBS
PALLET QTY	12	2323 LBS
LID	CP1730B	81 LBS
ENCLOSURE	BP173018B	106 LBS

PART DESCRIPTION:

17" x 30" x 18"
 POLYMER CONCRETE ASSEMBLY
 STRAIGHT WALL, OPEN BOTTOM

LOAD RATING:

- TIER 15
- TIER 22

BOLT DOWN:

- HEX HEAD (STANDARD)
- PENTA HEAD

LOGO OPTIONS:

- ELECTRIC
- COMMUNICATIONS
- FIBER OPTICS
- BLANK
- WATER
- LIGHTING
- STREET LIGHTING
- CAVITY (LOGO SOLD SEPARATELY)

*OTHER OPTIONS AVAILABLE (CONTACT FACTORY)

AVAILABLE OPTIONS:

- EMS MARKER, POWER
- EMS MARKER, TELEPHONE
- MOUSEHOLES
- CABLE RACKING (LOC. & QTY. REQ'D.)
- PULLING EYES

*OTHER OPTIONS AVAILABLE (CONTACT FACTORY)

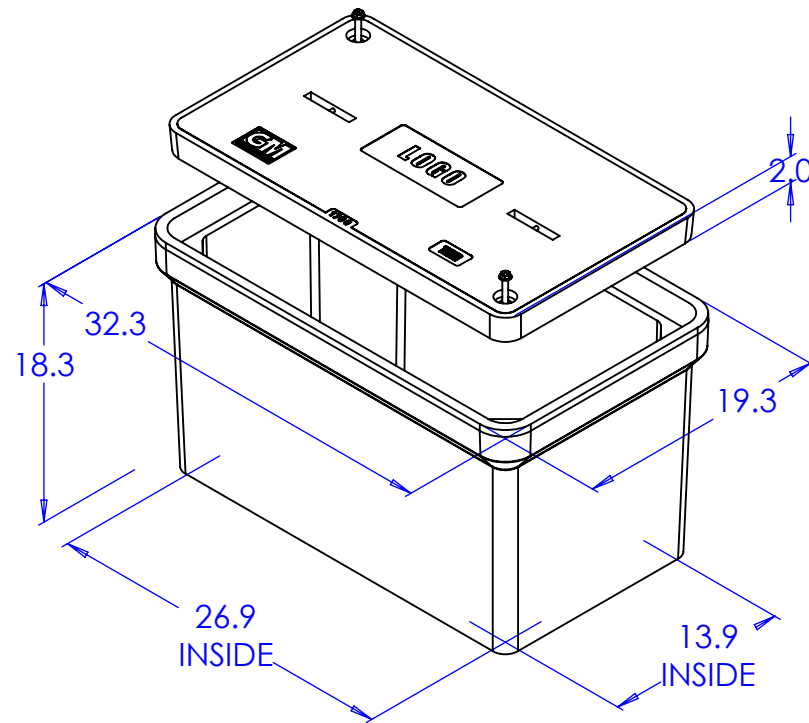
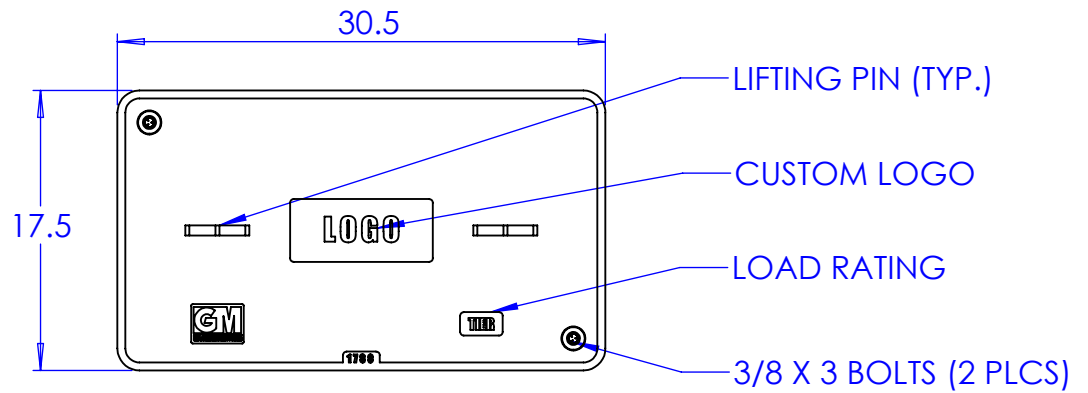

GLASMASTERS, INC.
 8873 WESTERN WAY, JAX., FL 32256
 (904) 400-7100 - (904) 358-1702 FAX
 WWW.GLASMASTERS.COM