



Catalog Number
Notes
Type

Contractor Select™

RB56A SWW5

RetroBasics™ 5"/6" Adjustable Switchable White LED Trim Kit

RetroBasics 5/6" Adjustable LED trim kits provide the most economical solution for efficiently lighting a space using LED technology with virtually zero maintenance. This LED adjustable module is designed to work in both 5" and 6" housings and can be used for accent lighting and wall washing in any room. Use as an option to replace legacy incandescent technology in an already installed housing or pair with the quick connect LED housings for a low-cost LED downlight solution. The LED trim maintains at least 70% light output for 50,000 hours.

FEATURES:

- 5 switchable white color temperatures to choose from via switch; 2700K, 3000K, 3500K, 4000K, 5000K CCT; 90 CRI. Switch is factory preset at 3000K CCT
- Dimmable flicker-free dimming from 100% to 10%
- Adjustable gimbal design provides 35° vertical aiming and 359° horizontal adjustment from below the ceiling
- Robust die cast aluminum trim frame for years of trouble free operation
- Flood optic (94 beam) with regressed, diffused lens provides even light distribution for accent lighting
- Trim features quick connect plug for easy electrical connection in seconds
- Torsion springs are pre-installed and designed to fit into most 5" or 6" compatible recessed housings

APPLICATIONS:

- Retrofit into existing recessed housings or use with quick connect housings for new construction or remodel applications
- Adjustable trim allows the user to aim the light which is perfect for accent lighting artwork, objects or other architectural details
- For use with housings installed in IC rated applications (direct contact with insulation)



RB56A



Catalog Number	UPC	Description	Replaces Up To	Lumens	Input Watts	CCT	CRI	Voltage	Finish	Dimming Protocol	Pallet qty.
RB56A SWW5 MW M6	00196182971471	5"/6" Adjustable Switchable White LED Trim Kit	75W Incandescent	800	9W	2700K-5000K	90	120V	White	100% to 10%	288



Pairs perfectly with Juno housings for a complete downlight solution: Order housings as separate catalog number.

QC6 Series - New Construction Quick Connect LED Housing



QC6R Series - Remodel Quick Connect LED Housing



PERFORMANCE DATA

RB56A	
Input Voltage	120V
Input Power Typical	9W (+/-5%)
Power Factor	.9
Frequency	60 Hz
EMI/RFI	FCC Title 47, Part 15 Class B (consumer)
Minimum Starting Temp	-20°C (-4°F) minimum

Note: Actual performance may differ as a result of end-user environment and application. All values are design or typical values, measured under laboratory conditions at 25° C

**LIGHTING PERFORMANCE DATA
DONNÉES SUR LE RENDEMENT
DE L'ÉCLAIRAGE**

Light Appearance (CCT)
Aspect de la lumière (CCT)

2700K soft white | blanc doux

850 lumens | 94 lumens per watt

3000K warm white | blanc chaud

870 lumens | 97 lumens per watt

3500K neutral white | blanc neutre

880 lumens | 98 lumens per watt

4000K cool white | blanc froid

850 lumens | 94 lumens per watt

5000K daylight | blanc neutre

820 lumens | 91 lumens per watt

Watts **9**

Color Accuracy (CRI) **90**
Précision des couleurs (CRI)



Specifications

ADJUSTABLE LED TRIM KIT:

Cast aluminum trim flange in matte white with molded thermal plastic gimbal housing • Up to 35° vertical adjustment and 359° horizontal rotation • Pressed-in diffusing lens optimized for concealing the LEDs from direct view in the on and off state • All-in-one design where LED light engine mounts directly to the trim for ease of installation into existing 5" or 6" recessed housings with medium base sockets or quick connect LED housings • Provided with torsion springs

LED LIGHT ENGINE:

LEDs are mounted directly to housing providing superior thermal management to ensure long life • Switchable white LED color temperature technology offers 2700K, 3000K, 3500K, 4000K, 5000K all in one trim • Switch factory set at 3000K • 90 CRI minimum • Accommodates 120 volts AC at 60Hz • Dimmable with most standard incandescent, magnetic low voltage and electronic low voltage dimmers • For a list of compatible dimmers, see [JUNORBSERIES-DIM](#).

OPTICAL SYSTEM:

Regressed, diffused lens at end of mixing chamber to provide even light distribution for accent lighting • Nominal 800L is equivalent to 75W BR30 lamp.

ELECTRICAL CONNECTIONS:

Trim features quick connect plug installed as standard for installation into Juno quick connect housings with mating connector • Trim ships with a medium base socket adapter whip for installation into 5" or 6" incandescent housings with medium base sockets.

LIFE:

Rated for 50,000 hours at 70% lumen maintenance.

LABELS:

ETL certified to US and Canadian safety standards • ENERGY STAR® certified product • Suitable for damp location • NOM Certified • Can be used to comply with California Title 24 Part 6 High Efficacy LED Light Source Requirements • T20 Certified.

TESTING:

All reports are based on published industry procedures; field performance may differ from laboratory performance.

WARRANTY:

5-year limited warranty. This is the only warranty provided and no other statements in this specification sheet create any warranty of any kind. All other express and implied warranties are disclaimed. Complete warranty terms located at: www.acuitybrands.com/support/warranty/terms-and-conditions

Note: Actual performance may differ as a result of end-user environment and application. All values are design or typical values, measured under laboratory conditions at 25 °C. Specifications subject to change without notice.

Dimensions

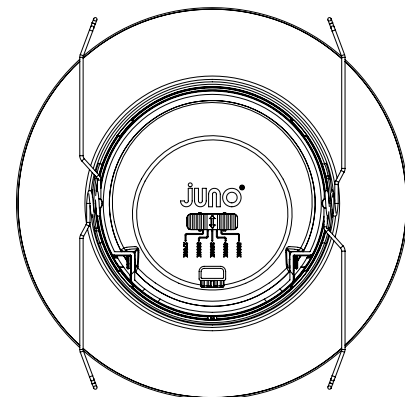
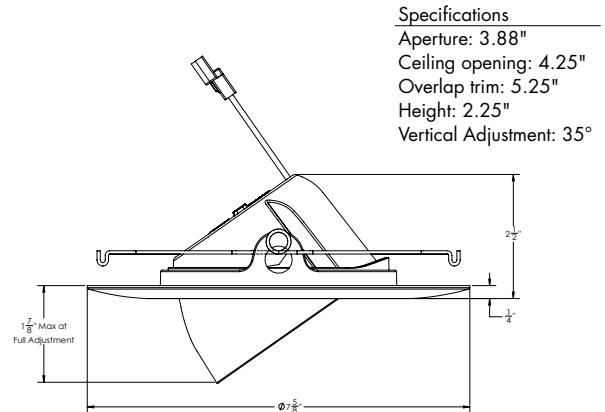



PHOTOMETRICS

RB56A SWW5 MW M6 - 2700K Input Watts: 9.0, Delivered Lumens: 851, LPW: 94.6, S/MH: 1.14, Test No: 22-552-2P1

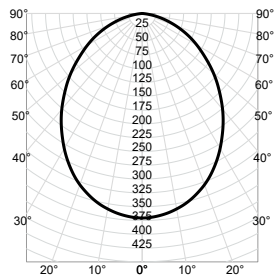

CP Summary		Zonal Lumen Summary		Coefficients of Utilization								Cone of Light			Luminance (cd/sq.m)		
0°	Zone	Lumens	% Fixture	pf	80%		20%		70%		50%		Mounting Height	Initial FC Center Beam	Beam Diameter	Average Luminance	
					pc	50%	30%	10%	50%	30%	10%	50%					30%
0°	0° - 30°	274	32%	0	119	119	119	116	116	116	111	111	111	6.0	10.3	12.9	0° 46,636
5°	0° - 40°	434	51%	1	105	101	98	103	100	96	99	96	93	8.0	5.8	17.2	45° 35,092
15°	0° - 60°	711	84%	2	93	86	81	91	85	80	87	83	78	10.0	3.7	21.5	55° 30,700
25°	0° - 90°	851	100%	3	82	75	68	81	74	68	78	72	67	12.0	2.6	25.9	65° 26,612
35°	90° - 180°	0	0%	4	73	65	59	72	64	58	70	63	57	14.0	1.9	30.2	75° 20,146
45°	0° - 180°	851	100%	5	66	57	51	65	57	51	63	56	50				85° 6,305
55°	140			6	60	51	45	59	51	45	57	50	44	Beam Angle: 94.3°			
65°	89			7	54	46	40	54	46	40	52	45	40	Field Angle: 152.0°			
75°	41			8	50	42	36	49	41	36	48	41	36				
85°	4			9	46	38	33	45	38	32	44	37	32				
90°	0			10	42	35	30	42	35	30	41	34	29				

RB56A SWW5 MW M6 - 3000K Input Watts: 9.0, Delivered Lumens: 871, LPW: 96.8, S/MH: 1.14, Test No: 22-552-2P2

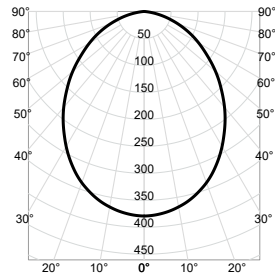

CP Summary		Zonal Lumen Summary		Coefficients of Utilization								Cone of Light			Luminance (cd/sq.m)		
0°	Zone	Lumens	% Fixture	pf	80%		20%		70%		50%		Mounting Height	Initial FC Center Beam	Beam Diameter	Average Luminance	
					pc	50%	30%	10%	50%	30%	10%	50%					30%
0°	0° - 30°	281	32%	0	119	119	119	116	116	116	111	111	111	6.0	10.5	12.9	0° 47,733
5°	0° - 40°	444	51%	1	105	101	98	103	100	96	99	96	93	8.0	5.9	17.2	45° 35,918
15°	0° - 60°	728	84%	2	93	86	81	91	85	80	87	83	78	10.0	3.8	21.5	55° 31,423
25°	0° - 90°	871	100%	3	82	75	68	81	74	68	78	72	67	12.0	2.6	25.9	65° 27,238
35°	90° - 180°	0	0%	4	73	65	59	72	64	58	70	63	57	14.0	1.9	30.2	75° 20,620
45°	0° - 180°	871	100%	5	66	57	51	65	57	51	63	56	50				85° 6,453
55°	143			6	60	51	45	59	51	45	57	50	44	Beam Angle: 94.3°			
65°	91			7	54	46	40	54	46	40	52	45	40	Field Angle: 152.0°			
75°	42			8	50	42	36	49	41	36	48	41	36				
85°	4			9	46	38	33	45	38	32	44	37	32				
90°	0			10	42	35	30	42	35	30	41	34	29				

RB56A SWW5 MW M6 - 3500K Input Watts: 9.0, Delivered Lumens: 881, LPW: 97.9, S/MH: 1.14, Test No: 22-552-2P3

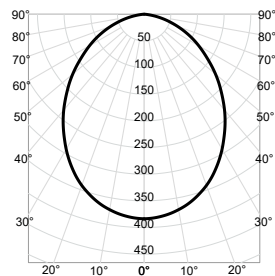

CP Summary		Zonal Lumen Summary		Coefficients of Utilization								Cone of Light			Luminance (cd/sq.m)		
0°	Zone	Lumens	% Fixture	pf	80%		20%		70%		50%		Mounting Height	Initial FC Center Beam	Beam Diameter	Average Luminance	
					pc	50%	30%	10%	50%	30%	10%	50%					30%
0°	0° - 30°	284	32%	0	119	119	119	116	116	116	111	111	111	6.0	10.7	12.9	0° 48,281
5°	0° - 40°	449	51%	1	105	101	98	103	100	96	99	96	93	8.0	6.0	17.2	45° 36,330
15°	0° - 60°	736	84%	2	93	86	81	91	85	80	87	83	78	10.0	3.8	21.5	55° 31,784
25°	0° - 90°	881	100%	3	82	75	68	81	74	68	78	72	67	12.0	2.7	25.9	65° 27,551
35°	90° - 180°	0	0%	4	73	65	59	72	64	58	70	63	57	14.0	2.0	30.2	75° 20,858
45°	0° - 180°	881	100%	5	66	57	51	65	57	51	63	56	50				85° 6,528
55°	145			6	60	51	45	59	51	45	57	50	44	Beam Angle: 94.3°			
65°	93			7	54	46	40	54	46	40	52	45	40	Field Angle: 152.0°			
75°	43			8	50	42	36	49	41	36	48	41	36				
85°	5			9	46	38	33	45	38	32	44	37	32				
90°	0			10	42	35	30	42	35	30	41	34	29				

RB56A SWW5 MW M6 - 4000K Input Watts: 9.0, Delivered Lumens: 851, LPW: 94.6, S/MH: 1.14, Test No: 22-552-2P4

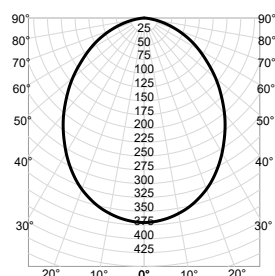

CP Summary		Zonal Lumen Summary		Coefficients of Utilization								Cone of Light			Luminance (cd/sq.m)		
0°	Zone	Lumens	% Fixture	pf	80%		20%		70%		50%		Mounting Height	Initial FC Center Beam	Beam Diameter	Average Luminance	
					pc	50%	30%	10%	50%	30%	10%	50%					30%
0°	0° - 30°	274	32%	0	119	119	119	116	116	116	111	111	111	6.0	10.3	12.9	0° 46,636
5°	0° - 40°	434	51%	1	105	101	98	103	100	96	99	96	93	8.0	5.8	17.2	45° 35,092
15°	0° - 60°	711	84%	2	93	86	81	91	85	80	87	83	78	10.0	3.7	21.5	55° 30,700
25°	0° - 90°	851	100%	3	82	75	68	81	74	68	78	72	67	12.0	2.6	25.9	65° 26,612
35°	90° - 180°	0	0%	4	73	65	59	72	64	58	70	63	57	14.0	1.9	30.2	75° 20,146
45°	0° - 180°	851	100%	5	66	57	51	65	57	51	63	56	50				85° 6,305
55°	140			6	60	51	45	59	51	45	57	50	44	Beam Angle: 94.3°			
65°	89			7	54	46	40	54	46	40	52	45	40	Field Angle: 152.0°			
75°	41			8	50	42	36	49	41	36	48	41	36				
85°	4			9	46	38	33	45	38	32	44	37	32				
90°	0			10	42	35	30	42	35	30	41	34	29				



PHOTOMETRICS

RB56A SWW5 MW M6 - 5000K Input Watts: 9.0, Delivered Lumens: 821, LPW: 91.2, S/MH: 1.14, Test No: 22-552-2P5

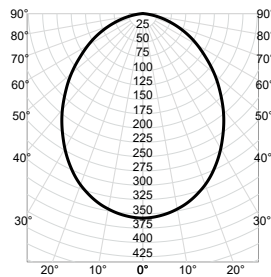

CP Summary		Zonal Lumen Summary		Coefficients of Utilization								Cone of Light			Luminance (cd/sq.m)			
0°	Zone	Lumens	% Fixture	pf	80%		70%		50%		Mounting Height	Initial FC Center Beam	Beam Diameter	Average Luminance				
				pc	50%	30%	10%	50%	30%	10%								
0°	357	0° - 30°	265	32%	0	119	119	119	116	116	111	111	111	6.0	9.9	12.9	0°	44,990
5°	354	0° - 40°	418	51%	1	105	101	98	103	100	96	99	96	8.0	5.6	17.2	45°	33,853
15°	335	0° - 60°	686	84%	2	93	86	81	91	85	80	87	83	10.0	3.6	21.5	55°	29,617
25°	297	0° - 90°	821	100%	3	82	75	68	81	74	68	78	72	12.0	2.5	25.9	65°	25,673
35°	246	90° - 180°	0	0%	4	73	65	59	72	64	58	70	63	14.0	1.8	30.2	75°	19,435
45°	190	0° - 180°	821	100%	5	66	57	51	65	57	51	63	56				85°	6,082
55°	135				6	60	51	45	59	51	45	57	50					
65°	86				7	54	46	40	54	46	40	52	45					
75°	40				8	50	42	36	49	41	36	48	41					
85°	4				9	46	38	33	45	38	32	44	37					
90°	0				10	42	35	30	42	35	30	41	34					

CBCP • Centerbeam candlepower
FC • Footcandles at beam center (aim point)

In vertical aiming applications, aim point (X) is determined by dividing distance from the wall (D) by the tangent of the desired aim angle (A) (0.5774 for 30°, 1.0 for 45°).

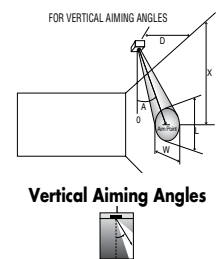
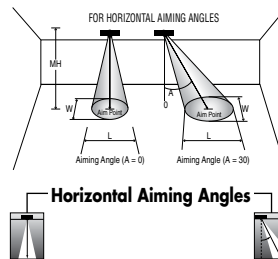

FIXTURE	BEAM SPREAD°	CBCP	0°				30°			30°				
			MH	FC	L	W	FC	L	W	D	FC	X	L	W
RB56A SWW5 MW M6 - 3000K	94°	379	3	42	6.5	6.5	27	14.0	7.5	1	49	1.7	*	4.3
			4	24	8.6	8.6	15	18.8	10.0	2	12	3.5	*	8.7
			5	15	10.8	10.8	10	23.5	12.5	3	5	5.2	*	12.9
			6	11	12.9	12.9	7	28.1	14.9	4	3	6.9	*	17.2
			7	8	15.1	15.1	5	32.8	17.4	5	2	8.7	*	21.6

*Covers full length of wall based on typical mounting heights of 8-12 feet.