



SCREW: 130051	MATERIAL: SEE NOTES 1 & 2	REV: M		
CAT. NO.: IPC-4/0-2/0 & IPC-4/0-2/0-B	PLATING: NONE	DRAWN BY: JG	SCALE: 1:2	800-776-9775 www.ilSCO.com
INFORMATION SHEET: FORM 73	MARKING: MAIN 4/0-2, TAP 2/0-6  	DATE: 2/8/2008	SIZE: A	DWG. NO. K0451
				SHEET: 1 OF 1



SCALE 1 : 1

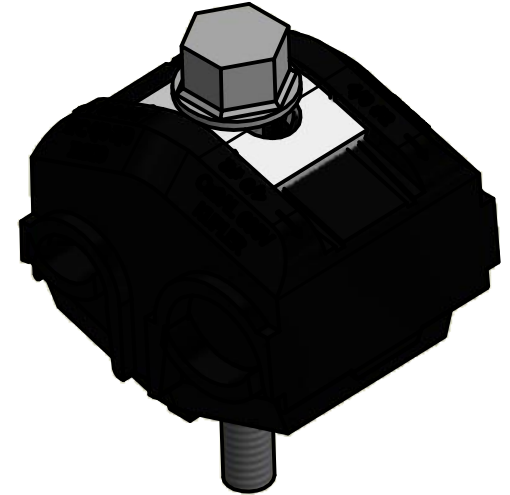
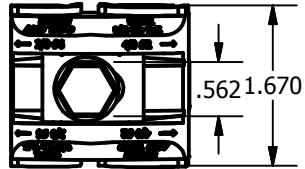
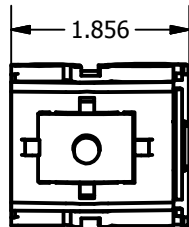
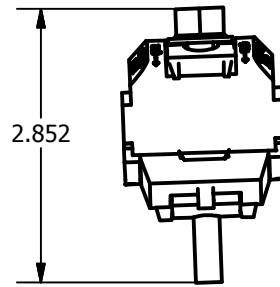
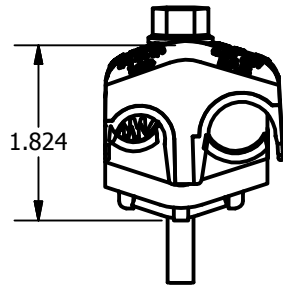

- NOTES:
1. NYLON BODY
 2. TIN PLATED COPPER TEETH
 3. WIRE RANGE: MAIN - 4/0 - 2
TAP - 2/0 - 6