

fiberglass BOX™

ISSUE DATE: 12/16/2014

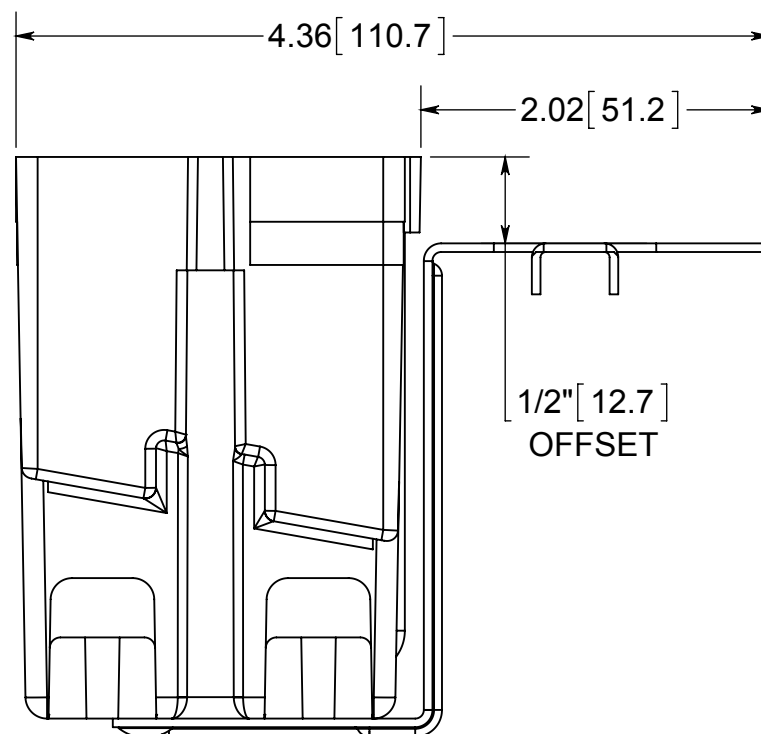
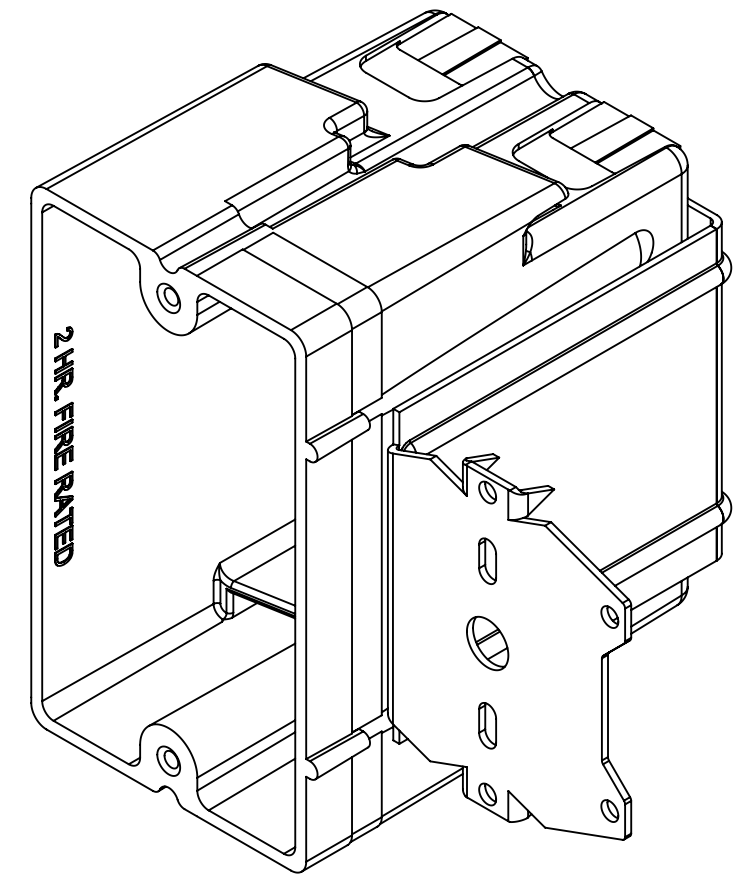
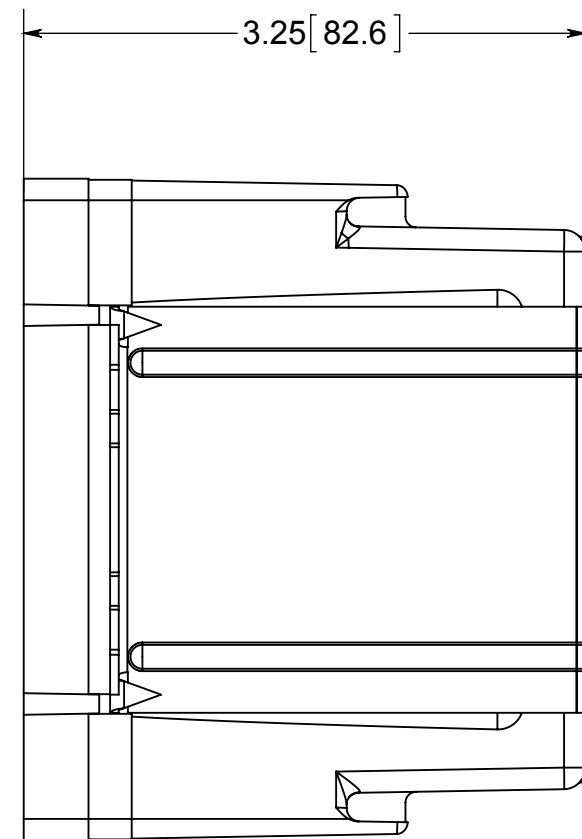
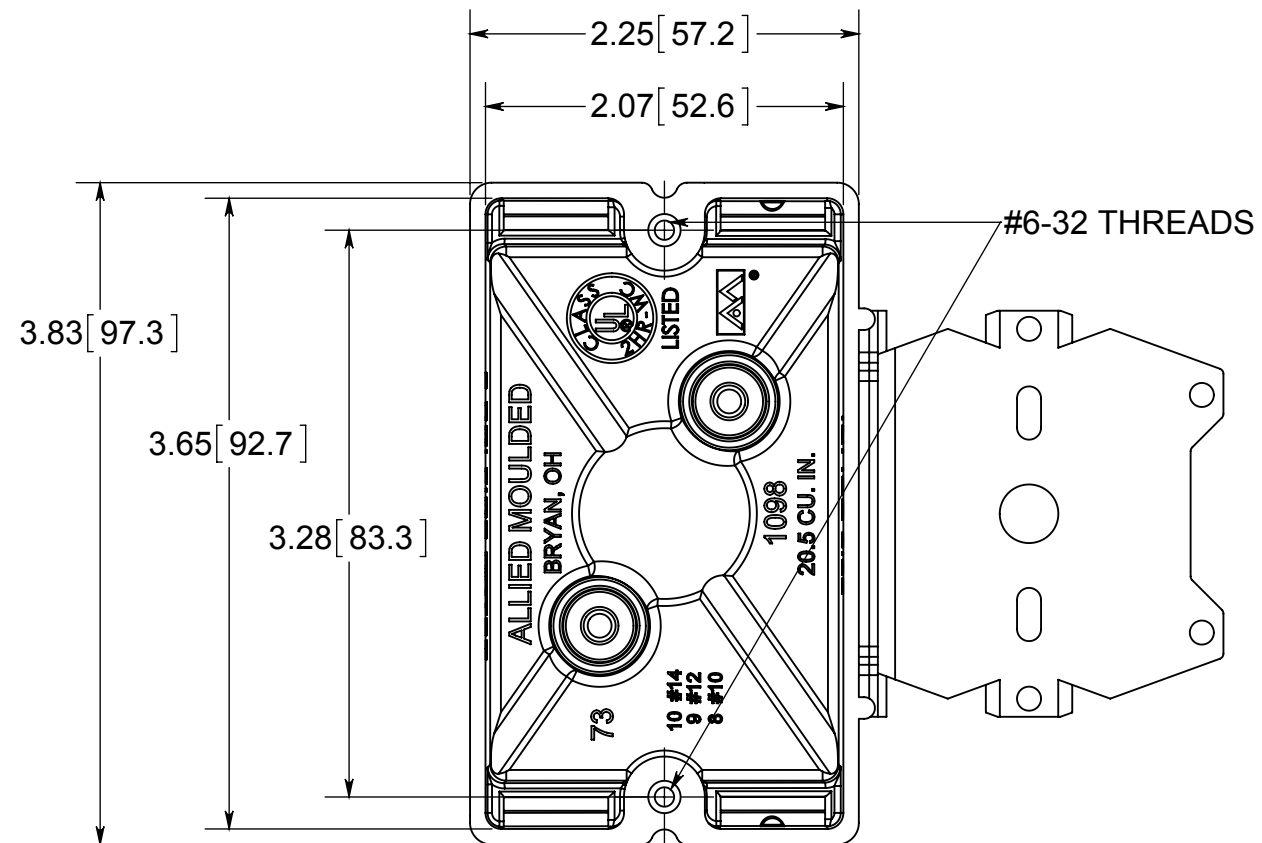

- NOTES:
- 1.) BOX MATERIAL: FIBERGLASS REINFORCED POLYESTER, BRACKET MATERIAL: GALVANIZED STEEL
 - 2.) UL LISTED WITH 2 HOUR FIRE RATING FOR WALL AND CEILING
 - 3.) "Z" HANGER BRACKET USED TO ATTACH BOX TO FACE OF WOOD OR STEEL STUDS. SECURE WITH APPROVED FASTENERS PER THE APPLICATION REQUIREMENTS.

 **ALLIED MOULDED PRODUCTS**
BRYAN, OHIO
The Original Fiber Glass Outlet Box

PRODUCT SERIES
SINGLE GANG 20.5 CU.IN.

Part No.
1098-Z4

CONFIDENTIAL
THIS MATERIAL IS OWNED BY THE ALLIED MOULDED PRODUCTS COMPANY, IS DISCLOSED IN CONFIDENCE, AND IS NOT TO BE REPRODUCED OR DISTRIBUTED WITHOUT PRIOR WRITTEN PERMISSION FROM ALLIED MOULDED PRODUCTS.