



4" LOW VOLTAGE UNIVERSAL IC NEW CONSTRUCTION HOUSING

50W MR16

IC44N SERIES

Project: _____

Fixture Type: _____

Location: _____

Contact/Phone: _____

PRODUCT DESCRIPTION

IC Air-Loc® New Construction Housing with all 4" trims complies with IECC, Washington State and other state Energy Codes • Double wall construction • Energy efficient, sealed inner housing does not require separate ALG gasket **G option** provides pre-installed Air-Loc gasket on mounting frame to seal between fixture and mounting surface • Air-Loc housing stops infiltration and exfiltration of air, reducing heating and cooling costs.

PRODUCT SPECIFICATIONS

Lamp One 12V, 50W MR16 lamp.

Socket Ceramic bi-pin socket with aluminum heat shield.

Trims Trim selection shown on page 3.

Transformer 120V to 12V 50VA thermally protected magnetic transformer mounted inside outer housing.

Dimming May be dimmed using dimmers specifically designed for low voltage magnetic transformers; consult factory or dimmer manufacturer for additional information.

Labels UL listed for through-branch wiring, damp locations and IP • Product thermally protected against improper use of lamps • Union made • UL Listed/CSA certified • Trim No. 441, 4401, 4402 and 4481 are wet location approved for covered ceiling applications.

Testing All reports are based on published industry procedures; field performance may differ from laboratory performance.

Specifications subject to change without notice.

INSTALLATION

Real Nail® Bar Hangers Telescoping, Patented (US Patent D552,969) Real Nail 3 and Real Nail 2 systems permits quick placement of housing anywhere within 24" O.C. joists or suspended ceilings • Bars scored in two locations for fast, clean breaking, allowing housing installation in tight applications • Bars captive to mounting frame • Edge-mounted for extra strength • Quick-Loc slot (location identified on the mounting frame) and oversized locking set screw lock fixture in position • May be installed either perpendicular or parallel to junction box.

Real Nail 3 Bar Hanger Integral T-bar notch and clip secures housing in suspended ceiling grid – no accessory clips required • 24" expansion stop allows quick placement of fixture in standard grid spacing • Captive bugle-headed ring shank nail for quick one-step installation and easy removal with claw hammer for fixture relocation • Bar hanger foot contoured to align to bottom of construction joist • Alternate mounting holes included.

Real Nail 2 Bar Hanger (S options) Small bar hanger foot designed to install directly on strapping construction material • Features Real Nail captive nail system for quick one-step installation • G2405 accessory clips required for suspended ceiling installation.

Junction Box Pre-wired junction box provided with (6) 1/2" and (1) 3/4" knockouts, (4) Non-metallic sheathed cable connectors and ground wire, U.L. listed/CSA certified for through-branch wiring, maximum 8 No. 12 AWG 90° C branch circuit conductors (3 in, 3 out) • Junction box provided with removable access plates • Knockouts equipped with pryout slots • **W options** are supplied with **push-in electrical connectors** for fast installation.

Mounting Frame 22-gauge die-formed galvanized steel mounting frame • Rough-in section (junction box, mounting frame, housing and bar hangers) fully assembled for ease of installation • Pre-installed Air-Loc gasket for **G options**.

Housing Air-Loc IC housing, .032" aluminum • Access door for junction box accessibility • Housing is vertically adjustable to accommodate up to a 1" ceiling thickness.

PRODUCT CODES

Catalog Number	Input Voltage	Lamp Rating
IC44N	120V	12V 50W MR16
IC44N G	120V	12V 50W MR16
IC44N S	120V	12V 50W MR16
IC44N S G	120V	12V 50W MR16
IC44N W	120V	12V 50W MR16
IC44N W G	120V	12V 50W MR16

Housing and trim can be ordered together or separate, but will always ship separately.

DIMENSIONS

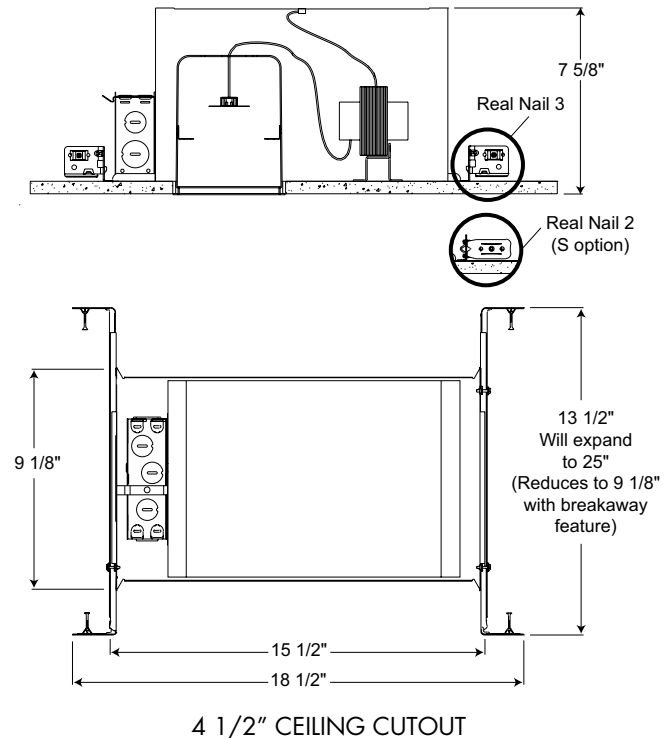

Accessories

Catalog Number	Description
4TSA	4" Housing Trim Adapter
G2405	T-Bar Clips (Set of 4), for S option only





























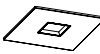







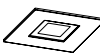

To order, specify catalog number.

4" LOW VOLTAGE UNIVERSAL IC NEW CONSTRUCTION HOUSING

50W MR16

IC44N SERIES

TRIMS/LAMPS

Catalog Number	Description	Catalog Number	Description
 	442 CWH 4" Downlight Deep Cone Trim - Clear Alzak® Cone, White Trim Ring	 	4480 FROST 4" Decorative Solid Glass Collar Trim - Frosted Glass (torsion spring attachment)
 	443 BWH 4" Downlight Pinhole with Baffle Trim - Black Baffle, White Trim Ring	 	4481 CLEAR ♦ 4" Decorative Frosted Glass Trim - Perimeter Frosted Clear Glass (torsion spring attachment)
 	440 WH 4" Adjustable Flush Gimbal Ring Trim - White		4475Q HZWH 4" Square Downlight Adjustable Trim - Haze, White Trim Ring
 	444 BWH 4" Adjustable Baffle Downlight Trim - Black Baffle, White Trim Ring		4475Q BWH 4" Square Downlight Adjustable Trim - Black, White Trim Ring
 	445 WH 4" Adjustable Slot Aperture Trim - White 50° Vertical Adjustment		4475Q WHZWH 4" Square Downlight Adjustable Trim - Wheat Haze, White Trim Ring 35° Vertical Adjustment
 	447 CWH 4" Adjustable Cone Downlight Trim - Clear Alzak® Cone, White Trim Ring		4435Q WH 4" Square Pinhole Trim - White
 	449 WH 4" Adjustable Aiming Elbow Trim - White		4405Q WH 4" Square Flush Gimbal Trim - White
 	441 WWH ♦ 4" Lensed Downlight Adjustable Trim - White, White Trim Ring		4405Q BL 4" Square Flush Gimbal Trim - Black 35° Vertical Adjustment
 	446 WH 4" Wall Wash Adjustable Scoop Trim - White 50° Vertical Adjustment		4415Q WWH ♦ 4" Downlight Adjustable Square Lensed Trim - White, White Trim Ring 35° Vertical Adjustment
 	4401 WH ♦ 4" Decorative Beveled Dome Lensed Trim - White		
 	4402 WH ♦ 4" Decorative Beveled Lensed Trim - White		
 	4403 FROSTWH 4" Decorative Beveled Cylinder Trim - Frosted Glass, White Trim Ring		
 	4404 HZSC 4" Decorative Beveled Cone Trim - Haze Cone, Satin Chrome Trim Ring		
 	4450 MESHSC 4" Decorative Glass Cylinder Trim - Mesh Glass, Satin Chrome Trim Ring		
			<p>Note: Lamps may be dimmed. Use dimmers specifically designed for low voltage magnetic transformers; consult factory or dimmer manufacturer for additional information. 50W MR16 maximum wattage when used with IC44N.</p> <p>Trim Size: 5" O.D.</p> <p>Alzak is a registered trademark of Alcoa Corp. Note: In Canada when insulation is present, Type IC fixtures must be used.</p> <p> JUNO IC housings meet IECC Energy Code requirements per ASTM E283.</p> <p>Air-Loc® rated trims are pre-gasketed for minimum air leakage with IC housings.</p> <p>♦ UL Listed for use in wet location.</p>