

SCREW: E1105
 CAT. NO.: TA-250
 INFORMATION SHEET: FORM 1

MATERIAL: ALUMINUM
 PLATING: EL-TIN
 MARKING: SEE CHART

REV: G
 DRAWN BY: NN
 DATE: 12/7/2007

ILSCO
 connections matter
 800-776-9775 www.ilsco.com



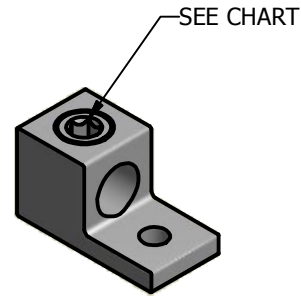
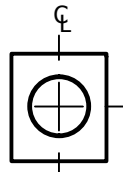
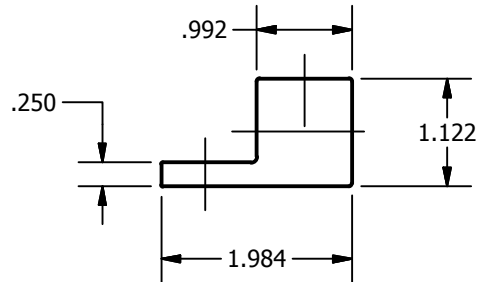
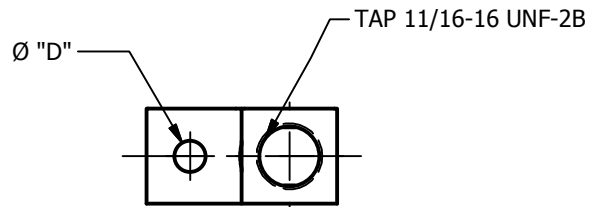
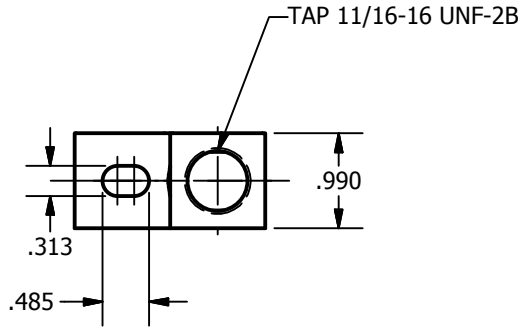



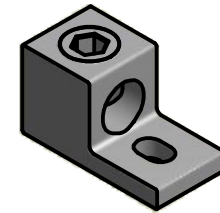



DWG. NO. D0831-22
 SHEET: 1 OF 1



SCALE 1 / 2



SCALE 1 / 2

DEV.	MOUNTING HOLE "D"	MARKING	SCREW
C10T	.328	BKB, ADR25, AL9CU, 250-6	E0953
C22T	.328	ILSCO, D831, TA-250, 250kcmil-6, AL9CU,  , 	E0939
C24T	.328	ILSCO, TA-250, CHD Z14/15, 250MCM-6, AL9CU,  , 	E0939
C25T	SLOT	ILSCO, D831, TA-250, 250kcmil-6, AL9CU,  , 	E1105
C43T	.531	ILSCO, D831, TA-250, 250kcmil-6, AL9CU,  , 	E0939
C46T	.406	ILSCO, D831, TA-250, 250kcmil-6, AL9CU,  , 	E0939