

FEATURES & SPECIFICATIONS

INTENDED USE — Available in several color temperatures, lumen packages and lengths. Ideal for use in commercial, retail, office, warehouse and display applications. **Certain airborne contaminants can diminish integrity of acrylic and/or polycarbonate.** [Click here for Acrylic-Polycarbonate Compatibility table for suitable uses.](#)

Certain airborne contaminants may adversely affect the functioning of LEDs and other electronic components, depending on various factors such as concentrations of the contaminants, ventilation, and temperature at the end-user location. [Click here for a list of substances that may not be suitable for interaction with LEDs and other electronic components.](#)

CONSTRUCTION — Compact-design channel and cover are formed from code compliant, 22 gauge cold-rolled steel.

SENSOR SWITCH JUST ONE TOUCH TECHNOLOGY — Single room control wireless technology available for easy install and commissioning to aid in code compliance. The JOT option enables the fixture with Just One Touch pairing capability. The JOTVIX15 option features a luminaire-embedded occupancy and ambient light sensor allows the luminaire to power off when the space is unoccupied or when enough ambient light is entering the space.

FINISH — High-gloss, baked white enamel (standard).

OPTICS — LEDs provide 80+ color rendering index (CRI) at 3500K, 4000K and 5000K. Diffuse acrylic lens with ultra-sonically welded end caps provides smooth, linear illumination.

ELECTRICAL — Luminaire Surge Protection Level: Designed to withstand up to 2.5kV/0.75kA per ANSI C82.77-5-2015. For applications requiring higher level of protection additional surge protection must be provided.

Driver is standard 0-10V dimming class 2.

INSTALLATION — Fixture may be surface or suspension mounted with appropriate mounting options (see accessories). Easy to install row aligner bracket included for continuous row mounting.

LISTINGS — CSA certified to US and Canadian safety standards and listed suitable for damp locations. Minimum starting temperature of -40°F (-40°C). Maximum ambient operating temperature of 95°F (35°C). See notes for controls temperature restrictions.

DesignLights Consortium® (DLC) qualified product. Not all versions of this product may be DLC qualified. Please check the DLC Qualified Products List at www.designlights.org/QPL to confirm which versions are qualified.

WARRANTY — 5-year limited warranty. Complete warranty terms located at: www.acuitybrands.com/support/warranty/terms-and-conditions

Note: Actual performance may differ as a result of end-user environment and application. All values are design or typical values, measured under laboratory conditions at 25 °C. Specifications subject to change without notice.

Catalog Number
Notes
Type



LED Strip Light

CSS



A+ Capable Luminaire

This item is an A+ capable luminaire, which has been designed and tested to provide consistent color appearance and out-of-the-box control compatibility with simple commissioning.

- All configurations of this luminaire meet the Acuity Brands' specification for chromatic consistency
- This luminaire is part of an A+ Certified solution for nLight® or XPoint™ Wireless control networks marked by a shaded background*

To learn more about A+, visit www.acuitybrands.com/aplus.

*See ordering tree for details

CSS LED Strip Light

CS Looking for Contractor Select readily available configurations? Click here to visit Contractor Select™ spec sheet or go to www.contractorselect.com

ORDERING INFORMATION Lead times will vary depending on options selected. Consult with your sales representative. **Example:** CSS L96 ALO4 MVOLT SWW3 80CRI

Series	Length	Lumen Output	Voltage	Color temperature	Color rendering index	Options
CSS Contractor Single Strip LED	L48 48"	4000LM 4000 Lumens ‡ ALO3 Switchable lumens, 3000LM / 4000LM / 5000LM	MVOLT 120-277V 347 347V ‡	35K 3500K ‡ 40K 4000K ‡ 50K 5000K ‡ SWW3 Switchable white, 35K / 40K / 50K	80CRI 80 CRI	JOT Enabled Wireless Controls: ‡ JOT Wireless room control with "Just One Touch" pairing JOTVTX15 Wireless occupancy sensor with "Just One Touch" pairing Individual Controls: SFR30CSS Factory installed 360°, large motion, high bay sensor, SFR 30 ‡ SFR7CSS Factory installed 360°, small motion, low bay sensor, SFR 7 ‡ Wire Guard: WG Wire Guard
	L96 96"	8000LM 8000 Lumens ‡ ALO4 Switchable lumens, 6000LM / 8000LM / 10000LM				

NOTE: ‡ indicates option chosen has ordering restrictions. Please reference ordering restrictions chart.

Accessories: Order as separate catalog number.	
HC36 M12	Hanger chain, 36" (1 pair)
ZACVH M100	Adjustable 10' aircraft cable with Y hanger (1 pair)
SQ_	Swivel stem hanger (specify length in 2" increments up to 48")
rPP20D	nLight® air dimming/switching module
SFR30CSS	Field installed 360°, large motion, high bay sensor, SFR 30 ‡
SFR7CSS	Field installed 360°, small motion, low bay sensor, SFR 7 ‡
Y J10	Y hanger in multiples of 10 (five pair)
WGCSS	Wire Guard with Mounting hardware (one 4ft)
MNLK JBOXCVR M12	Junction box cover and hardware, white

‡ Option Value Ordering Restrictions	
Option value	Restriction
35K, 40K, 50K	Not available with ALO lumen packages.
4000LM, 8000LM	Not available with SWW3.
JOT Enabled Controls	Not available with ALO3, ALO4, 347V or SWW3. Not intended for continuous row mount applications. Minimum starting temp of 14°F (-10°C). Maximum operating temp of L48 at 95°F (35°C) & L96 at 86°F (30°C).
SFR Sensors	Not available with 347V. Can only be mounted at the end of continuous row mount applications. On/off function only. Minimum starting temp of 14°F (-10°C).
Wire Guard	Does not cover Controls.

EMERGENCY BATTERY PACKS

Factory-Installed Nomenclature	Battery Part Number	Suitable for Field Installation	T20?
-	ILBLP-CP10-HE-SD-A	Yes	Yes

OPERATIONAL DATA

Length	Nominal Lumen Package	Color Temperature	Delivered Lumens	Wattage	Lumens/Watt	
L48	4000 LM	4000K	4,298	35.3	121.8	
		3500K	3,190	27.7	115.4	
		5000K	3,250	27.7	117.5	
	ALO3 (3000 LM)	3500K	4,135	35.8	115.4	
		4000K	4,206	35.8	117.3	
		5000K	4,268	35.8	119	
		ALO3 (4000 LM)	3500K	5,058	43.9	115.1
			4000K	5,150	43.9	117.2
			5000K	5,274	43.9	120.1
	L96	8000 LM	4000K	8,596	72	119.3
			3500K	6,380	55.3	115.4
			5000K	6,501	55.3	117.5
ALO4 (6000 LM)		3500K	8,271	71.7	115.4	
		4000K	8,413	71.7	117.3	
		5000K	8,535	71.7	119	
		ALO4 (8000 LM)	3500K	10,115	87.9	115.1
			4000K	10,300	87.9	117.2
			5000K	10,549	87.9	120.1

PROJECTED LUMEN MAINTENANCE			
Lumen Maintenance Factor	0.91	0.81	0.75
Operating Hours	40,000	90,000	120,000

*Actual performance may vary based on ambient temperature of installed location.

*All values are typical and are at 25C. Actual performance may vary and is dependent on operating environment.

DIMENSIONS

All dimensions are shown in inches unless otherwise noted.

Length	Width	Height	Approximate weight	Fixtures per pallet	Pallet Dimensions
L48	2.62	2.22	5 lbs	98	46 x 57
L96	2.62	2.22	10 lbs	102	46 x 98.5

*Weights will vary slightly with added options.

4FT Assembly

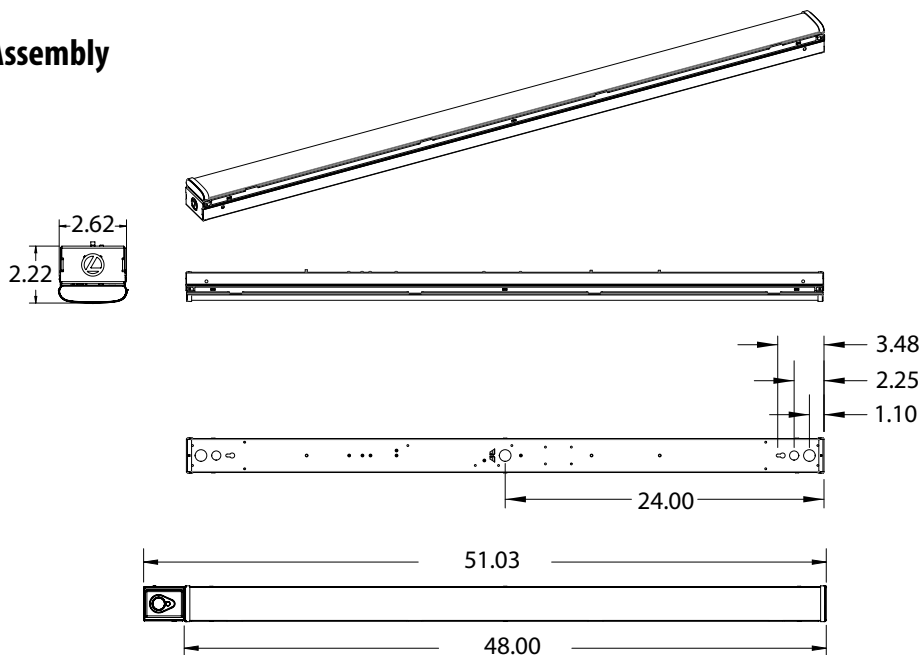

DIMENSIONS

All dimensions are shown in inches (centimeters) unless otherwise noted.

8FT Assembly

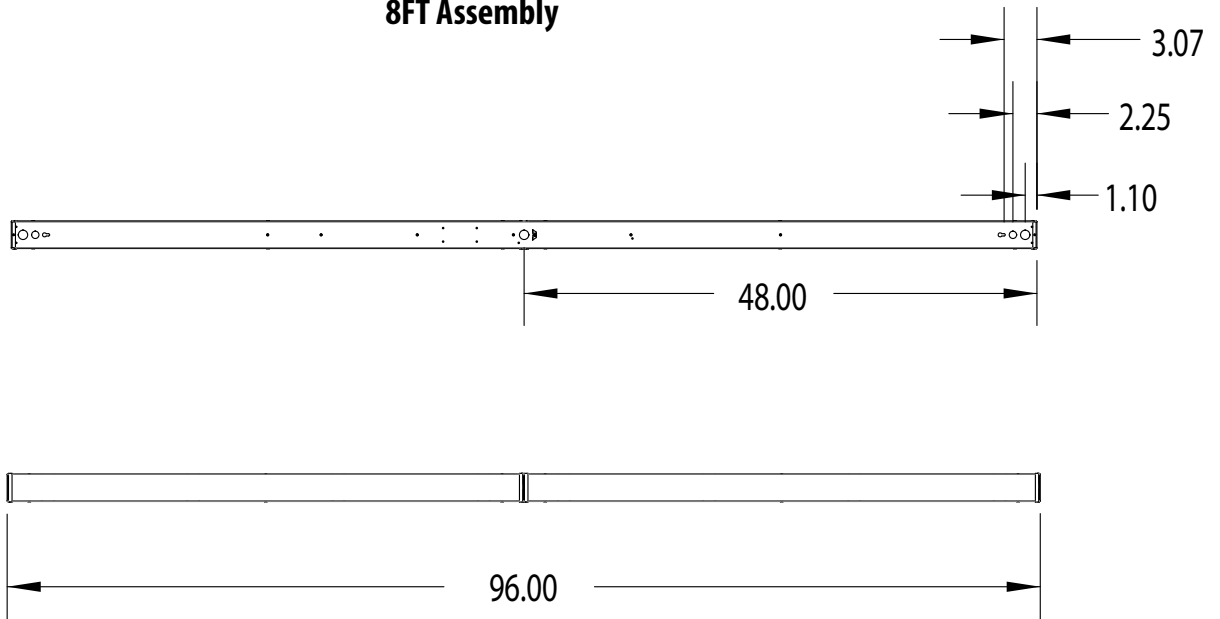

INDIVIDUAL CONTROLS COVERAGE PATTERNS

SFR 30 UNIVERSAL 360° LENS

- Provides excellent detection of large motion (e.g. walking) when mounted between 15 to 40 ft (4.57 to 12.19 m)
- 15 to 20 ft (4.57 to 6.10 m) radial coverage overlaps area lit by a typical high bay fixture
- Recommended for fixtures that have a 1:1 spacing to mounting height ratio or less (e.g. fixtures 30' on center or less @ a 30' mounting height).

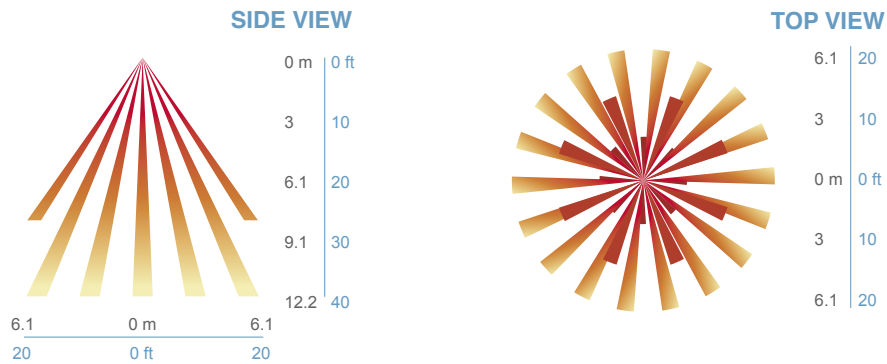

SFR 7 MINI LOW BAY 360° LENS

- Recommended for walking motion detection from mounting heights between 8 ft (2.44 m) and 20 ft (6.10 m)
- Initial detection of walking motion along sensor axes at distances of 2x the mounting height up to 15 ft (4.57 m) and 1.75x up to 20 ft (6.10 m).
- Provides 12 ft (3.66 m) radial detection of small motion when mounted at 9 ft (2.74 m)
- Initial detection will occur earlier when walking across sensor's field of view than when walking directly at sensor

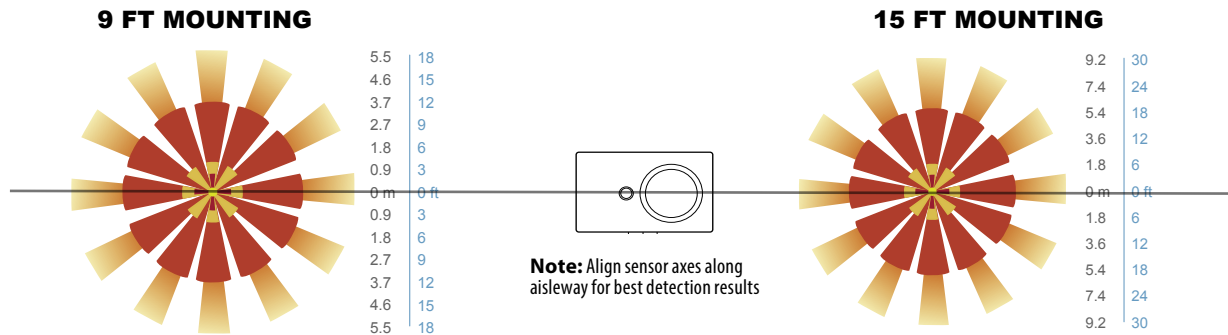

MAXIMUM # OF FIXTURES PER SFR SENSOR

Nomenclature	Maximum # of Fixtures per SFR SENSOR
CSS L48 4000LM MVOLT	20
CSS L48 ALO3 MVOLT	16
CSS L96 8000LM MVOLT	10
CSS L96 ALO4 MVOLT	8

JOT ENABLED WIRELESS CONTROLS

TYPICAL SMALL ROOM APPLICATION (UP TO 250 SQ. FT.)

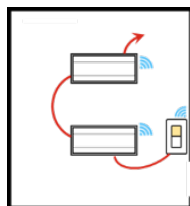

One Entryway
1x WSXA JOT
2x JOT Enabled Fixture

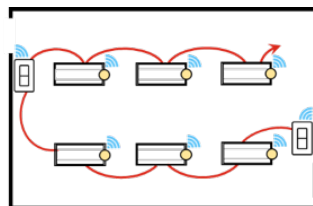

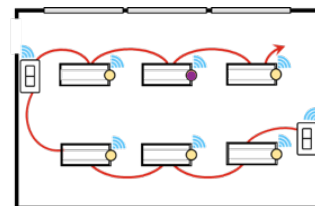

Two Entryways
2x SPODMRA JOT
6x JOT Enabled Fixture with Occupancy Sensor



Two Entryways with Daylight Harvesting
2x SPODMRA JOT
1x JOT Enabled Fixture with Photocell and Occupancy Sensor
5x JOT Enabled Fixture with Occupancy Sensor

JOT ENABLED PRODUCT PORTFOLIO

CONTROLS

 Sensor Switch WSXA JOT Wall Switch Sensor with Dimming	 Sensor Switch SPODMRA JOT Wall Switch with Dimming	 Sensor Switch CMSB JOT Ceiling Mount Sensor, Battery-Powered	 Sensor Switch VERTEX JOT Embedded Occupancy and Daylight Harvesting Sensor
---	---	---	---

PHOTOMETRICS

Please see www.lithonia.com.